

# Versaliner® Data Sheet Details

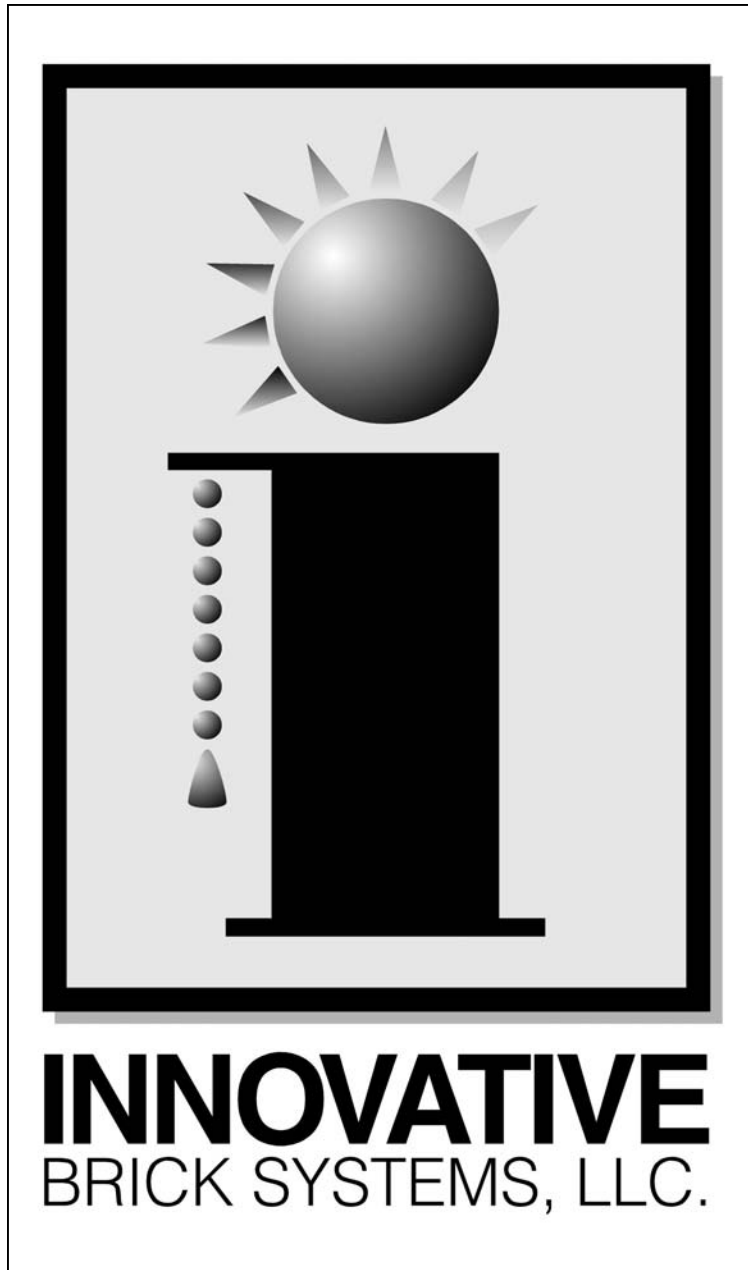

*“Innovation Drives Us”*



# Table of Contents

## Modular Patterns

5.	100	Modular running bond basic cope joint
6.	101	Modular running bond compression fit joint
7.	110	Modular running bond compression fit textured joint
8.	110.01	Modular running bond compression fit textured joint
9.	110.02	Modular running bond (-1/16th) compression fit textured joint
10.	110.03	Modular running bond (+1/16th) compression fit textured joint
11.	100 ECO	ECO modular running bond - multi use
12.	100.3/16	W 3/16" shallow cope joint
13.	103	Modular running bond 3/8" bed joint
14.	104	Modular corner molded cope
15.	105.1	Modular running bond grapevine joint
16.	106	Modular return coped to 7 5/8 "
17.	107	Modular return coped to 3 5/8"
18.	109	Modular return with boot 7 5/8"
19.	115	Modular folding corner
20.	117	Modular folding corner long 42 11/16" length
21.	120	Modular stack bond
22.	121	Modular Soldier Grapevine
23.	124	Modular half stretchers
24.	125-3x	Modular 3x Soldier compression fit textured joint
25.	125 B	Modular soldier single row offset with plus minus
26.	125.01	Modular soldier offset saddles compression fit textured joint
27.	127	Modular Soldier No Saddles
28.	138	Modular stretcher course recessed 1/2"
29.	141	Modular Flemish bond every row
30.	152	Rough brick running bond 7/16" deep joint
31.	161L	Left Starter to adjust layout minus 3/16" used with 161R for minus 3/8"
32.	161R	Right Starter to adjust layout minus 3/16" used with 161L for minus 3/8"
33.	170	V-Joint modular Flemish bond rough brick soldier
34.	180	Modular running bond 1/8" deep RAKE joint
35.	126	Rough Brick Soldier
36.	3500c	Modular herringbone

## Modular Specials

37.	S-101	Modular running bond compression joint special vertical adjustment
38.	S116	Modular running bond and closure with drip edge
39.	S-122L	Modular running bond expanded joint for 5'4" width - left
40.	S-122R	Modular running bond expanded joint for 5'4" width - right
41.	S123	Modular running bond expanded joint for 4'4" width
42.	S128	Modular running bond w/compressed head joints
43.	S129	Modular soldier w/compressed bed joints
44.	S143	Modular running bond w/Flemish course every 6 rows

## Closure Patterns

45.	200	Closure running bond
46.	215	Closure folding corner
47.	226	Closure soldier stack no saddles
48.	200.1	Closure running bond compression fit joint
49.	225.1	Closure soldier compression fit joint

# Table of Contents

## Norman Patterns

50.	300	Norman Third Bond
51.	320	Norman Stacked Bond 3 wide
52.	321	Norman Stacked Bond 4 wide

## Utility Patterns

53.	400	Utility running bond half bond
54.	401	Utility one third bond RAKE joint
55.	402	Utility one third bond
56.	405	LR Utility corner adjustment piece
57.	420 3x	Utility stack bond 3x
58.	421B	Utility Stack bond Rake joint 3x
59.	422	Utility half bond rows 2 & 5 recessed 3/8"
60.	423	Utility half bond rows 3 & 4 recessed 3/8"
61.	424	Utility half bond alternating recessed course
62.	425	Single row utility soldier offset saddles
63.	453	3 rows 4 by 4
64.	470	Utility herringbone
65.	5403	Utility one third bond RAKE joint +1/16" pocket

## Tile & Stone

66.	810	Split Face 8x16 - 1/2 bond base w/crush pad
67.	822	Tile 4x24 and 12x24 special w/1/4" joint
68.	830	8x8 Stack layout
69.	860	VersaStone base
70.	870	Metallic brick running bond
71.	870M	Metallic brick running bond metric
72.	871M	Metallic brick stack bond metric
73.	871	Metallic brick stack bond

## Miscellaneous Sizes

74.	S203	Special 2 3/4" x 7 5/8" running bond compression fit textured joint
75.	S310	King 2 5/8" x 9 5/8" - 3/8" joint third bond
76.	S701	Utility 3 3/8" x 11 1/4" third bond
77.	S702	Roman (1 5/8" x 11 5/8") third bond
78.	416	4 x16 1/2 bond 7/16" joint
79.	416.1	4x16 1/2 bond with false joint in center

# Table of Contents

## Special Arches

81.	SA201	4x4 Arch Pattern
82.	SA125	Arch 5' 4 3/16" radius
83.	SA126	Arch 4' 2 3/16" radius
84.	SA127	Arch sunburst with Flemish bond inside
85.	SA128	Two piece Jack arch
86.	SA129	Jack arch
87.	SA130	Jack arch
88.	SA131	Special arch
89.	SA135	Special arch
90.	SA136	Special arch
91.	SA137a	Special arch
92.	SA137b	Special arch

## Metric Sizes

93.	4100	215mm x 65mm running bond
94.	4120	215mm x 65mm stack course
95.	4215	215mm x 65mm soldier course

## Miscellaneous

96	903	Edge Strip 3/8"
97	905	Edge Strip 5/8"
98	XXX	Versaliner brick gauge compression fit joint
99.	XXX	Versaliner joint options
100.	XXX	Design you own liner!

## Recent Additions

<b>101.</b>	<b>S258</b>	<b>2 1/2" x 8" Brick w/1/2" raked joint</b>
102.	862	8x8 Smooth Face Fingerjoint Liner
103.	101.2	Modular running Bond, compression fit Vertical joint
104.	110.011	Modular running bond, CFTJ +3/16 per sheet adjustment
105.	125.012	Modular soldier, CFTJ +3/16 per 32" adjustment
106.	S-130	Modular Running Bond 2 ft column liner

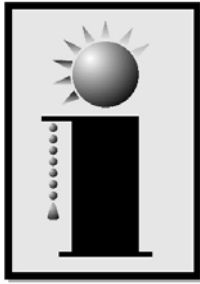

**INNOVATIVE**  
BRICK SYSTEMS, L.L.C.

Innovative Brick Systems, L.L.C.  
11625 Reed Ct.  
Broomfield, Co. 80020  
800-413-4588

## VersaLiner® #100 Modular Running Bond

Patent Number: D,479,614

### Dimensions

A... 7 5/8"  
B... 2 1/4"  
C...\* 32 "  
D... 3/8"  
E...\* 26.67"  
F... .4166"

\* ±1/8" for normal thermal expansion and contraction

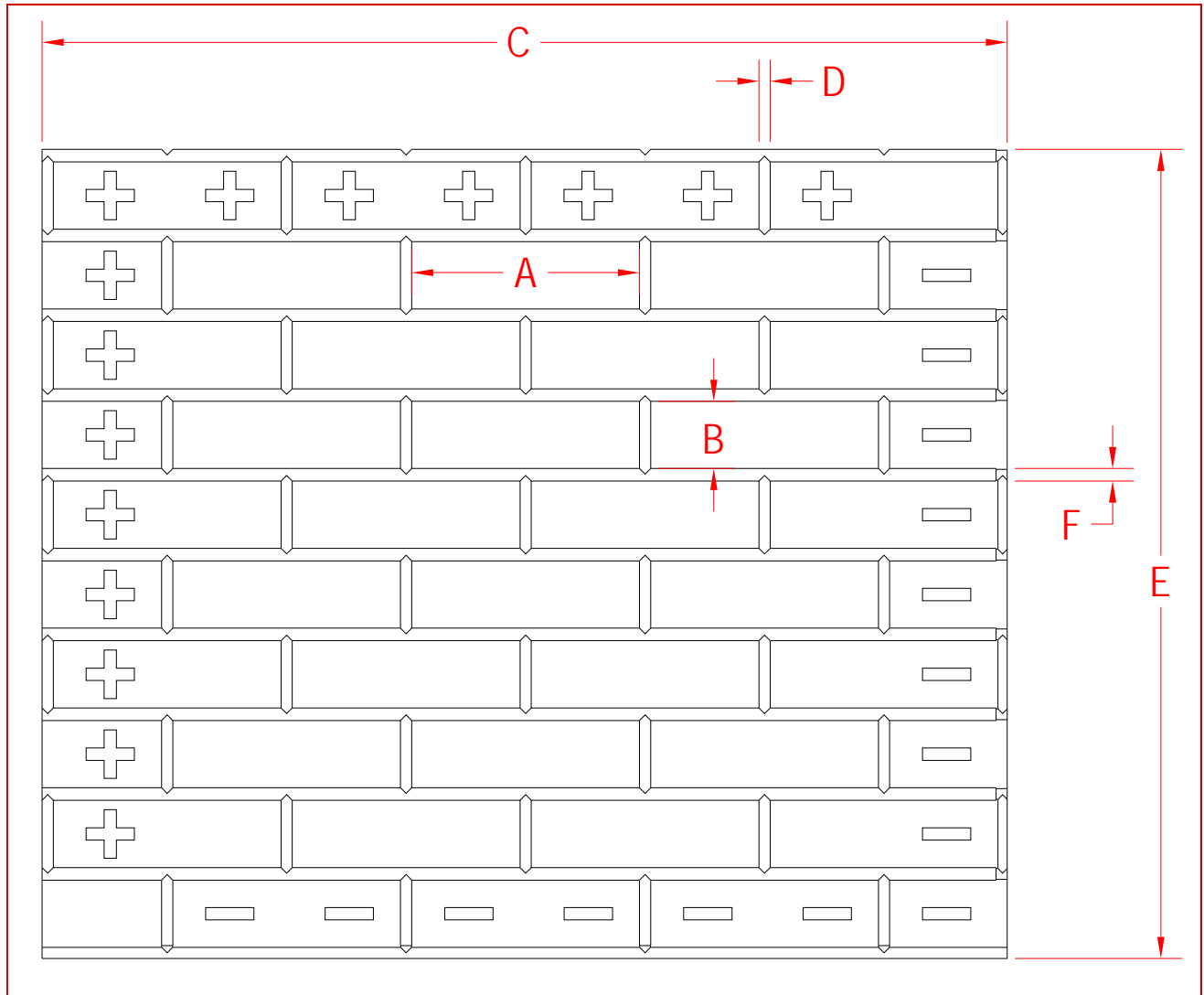

### Coverage / Piece

Square Feet.... 5.92  
Linear Feet.... 2.66

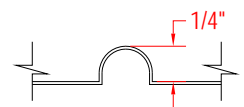

COVE JOINT

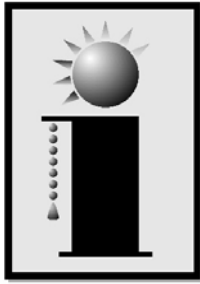

**INNOVATIVE**  
BRICK SYSTEMS, L.L.C.

Innovative Brick Systems, L.L.C.  
11625 Reed Ct.  
Broomfield, Co. 80020  
800-413-4588

**VersaLiner®**  
**#101 Modular Running Bond**  
**Compression Fit Joint\*\***

Patent Number: D,479,614

**Dimensions**

A... 7 5/8"\*\*\*  
B... 2 1/4"  
C...\* 32 3/8"  
D... 3/8"  
E...\* 27.08"  
F... .4166"

\* ±1/8" for normal thermal expansion and contraction

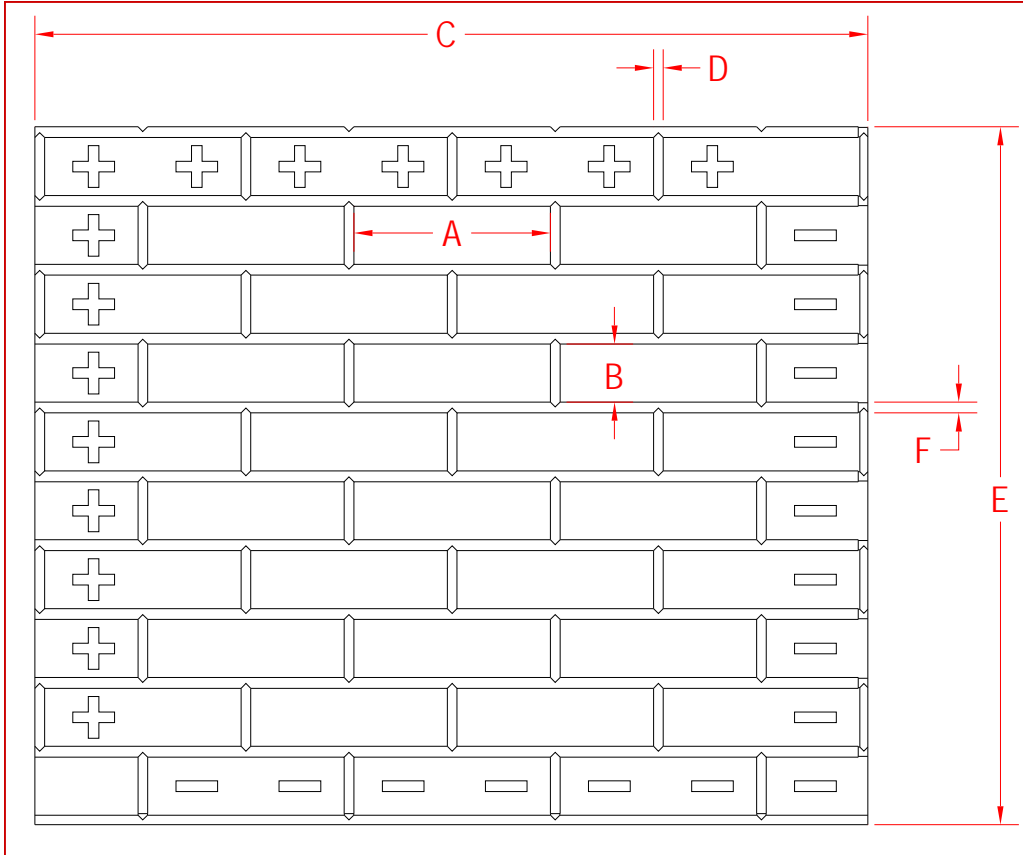

- \*\*CF—"compression fit"
- Pocket will conform to brick size 7 5/8" (+/- 1/16th")

**Coverage / Piece**

Square Feet.... 5.92  
Linear Feet.... 2.66

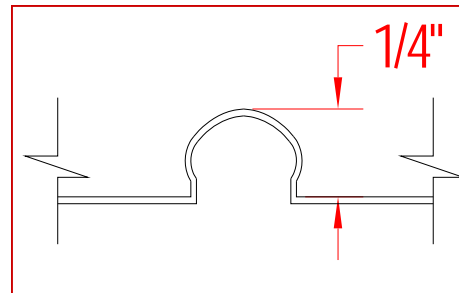

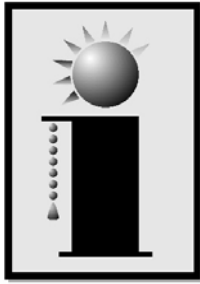

**INNOVATIVE**  
BRICK SYSTEMS, L.L.C.

Innovative Brick Systems, L.L.C.  
11625 Reed Ct.  
Broomfield, Co. 80020  
800-413-4588

**VersaLiner®**  
**#110**

**Modular Running Bond**  
**Compression Fit Textured Joint\***

Patent Number: D,479,614

**Dimensions**

- A... 7 5/8N" \*\*
- B... 2 1/4"
- C... \* 40"
- D... 3/8"
- E... \* 21.33 "
- F... .417"

\* ±1/8" for normal thermal expansion and contraction

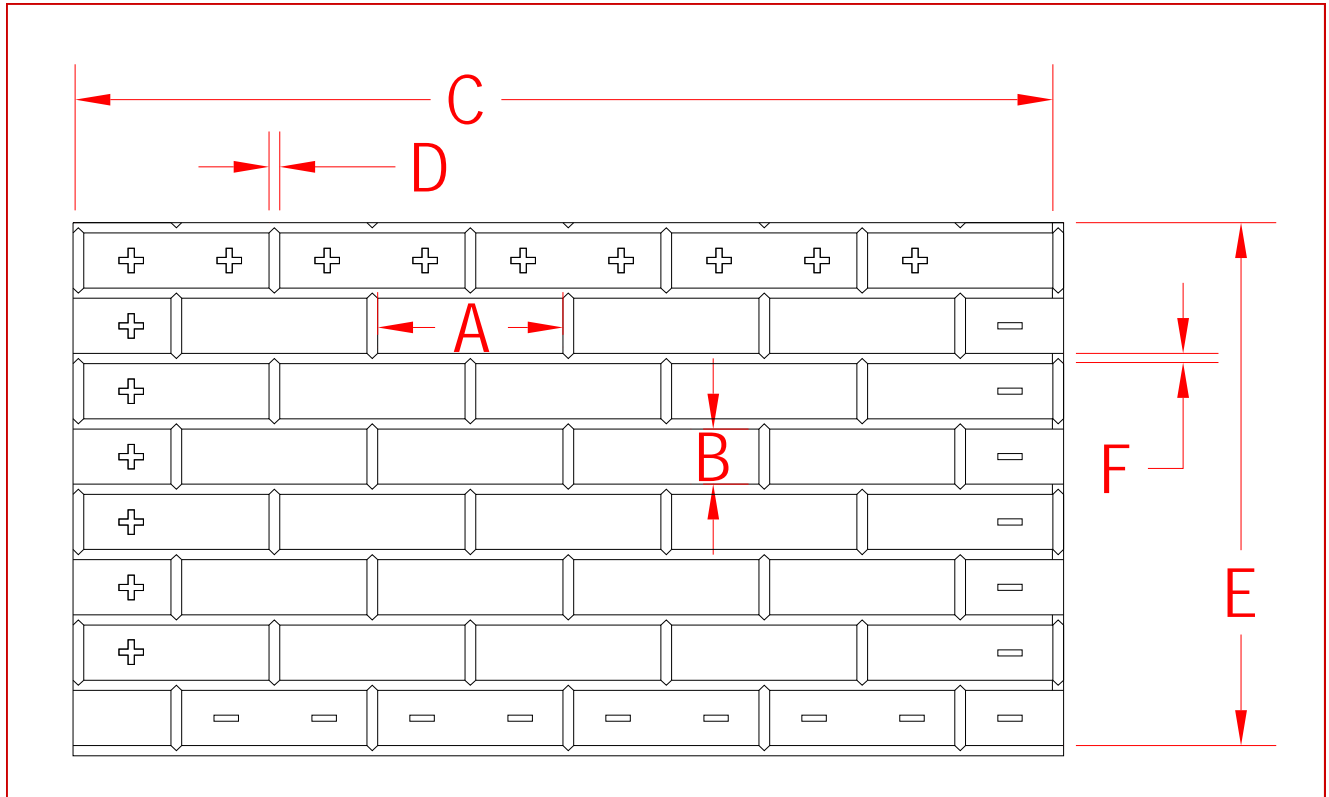

- \*\*CFTJ—"compression fit" textured joint
- Pocket will conform to brick size 7 5/8" (+/- 1/16th")

**Coverage / Piece**

Square Feet.... 5.92  
Linear Feet..... 3.33

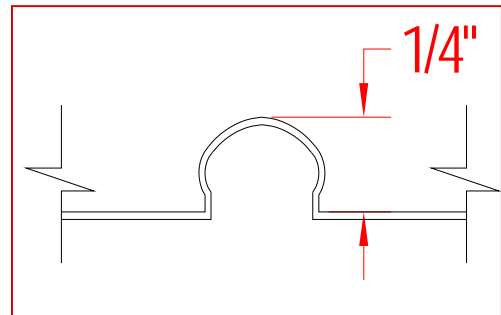

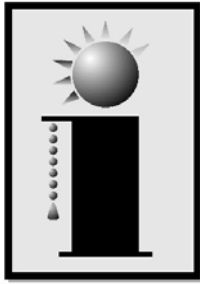

**INNOVATIVE**  
BRICK SYSTEMS, LLC.

Innovative Brick Systems, L.L.C.  
11625 Reed Ct.  
Broomfield, Co. 80020  
800-413-4588

**Dimensions**

A... 7 5/8N" \*\*  
B... 2 1/4"  
C... \* 32  
D... 3/8"  
E... \* 26.33"  
F... .4166"

\* ±1/8" for normal thermal expansion and contraction

**VersaLiner®  
#110.01**

**Modular Running Bond  
Compression Fit Textured Joint\*\***

Patent Number: D,479,614

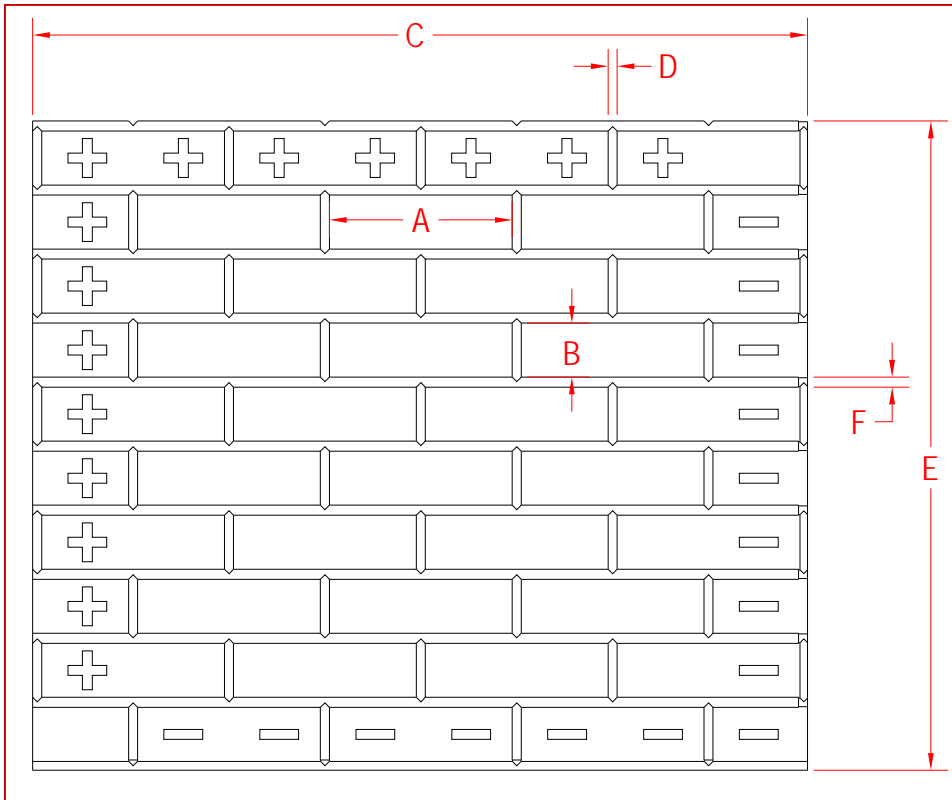

- **\*\*CFTJ**—"compression fit"
- **Pocket** will conform to brick size approx. 7 9/16" - 7 11/16"

**Coverage / Piece**

Square Feet.... 5.92  
Linear Feet.... 2.66

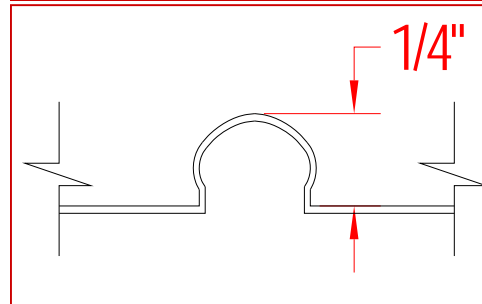

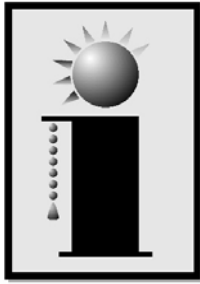

**INNOVATIVE**  
BRICK SYSTEMS, L.L.C.

Innovative Brick Systems, L.L.C.  
11625 Reed Ct.  
Broomfield, Co. 80020  
800-413-4588

**VersaLiner®**  
**#110.02**

**Modular Running Bond**  
**Compression Fit Textured Joint\***

Patent Number: D,479,614

**Dimensions**

A... 7 9/16"\*\*\*  
B... 2 1/4"  
C...\* 48"  
D... 7/16"N  
E...\* 21.33 "  
F... .417"

\* ±1/8" for normal thermal expansion and contraction

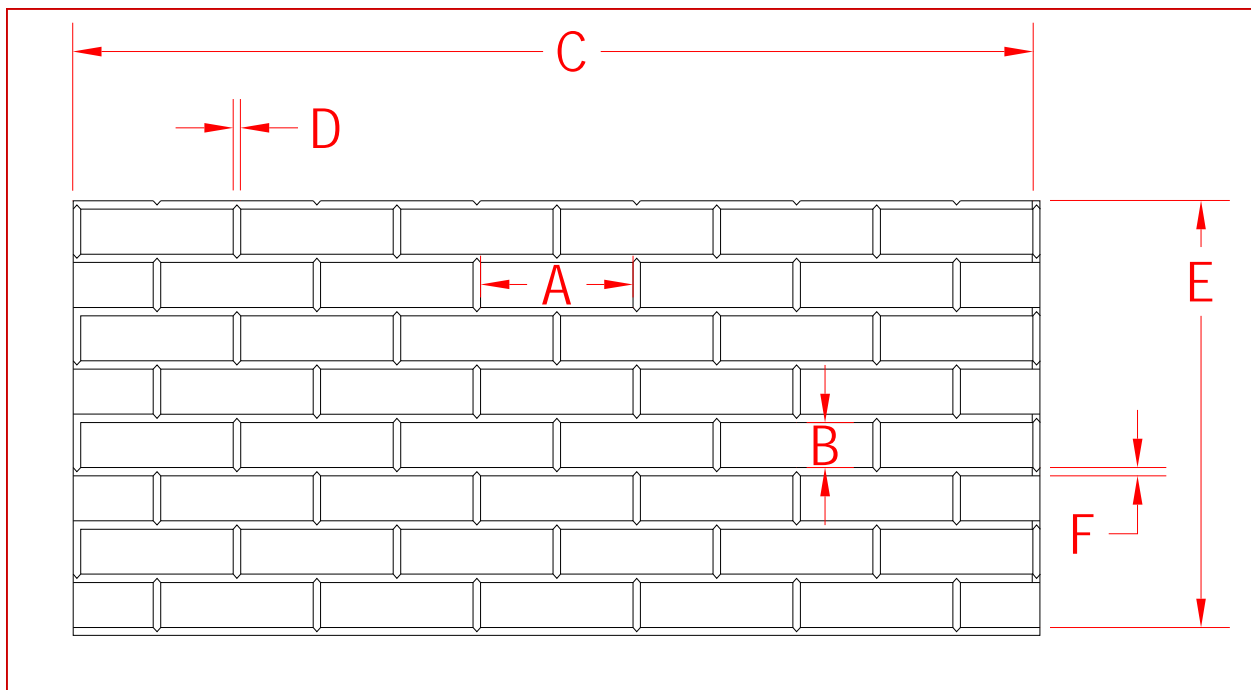

- **\*\*CFTJ—“compression fit” textured joint**
- **Pocket will conform to brick size approx. 7 1/2” - 7 5/8”**

**Coverage / Piece**

Square Feet.... 7.11  
Linear Feet..... 4

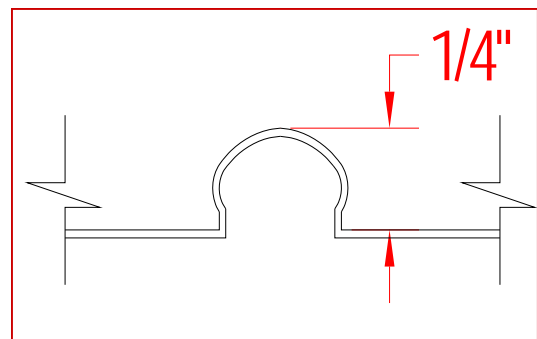

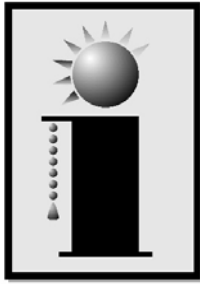

**INNOVATIVE**  
BRICK SYSTEMS, L.L.C.

Innovative Brick Systems, L.L.C.  
11625 Reed Ct.  
Broomfield, Co. 80020  
800-413-4588

**Dimensions**

A\*\* 7 11/16" N  
B... 2 1/4"  
C... 48"  
D... 5/16" N  
E... 21.33 "  
F... .417"

\* ±1/8" for normal thermal expansion and contraction

**VersaLiner®**  
**#110.03**

**Modular Running Bond**  
**Compression Fit Textured Joint\***

Patent Number: D,479,614

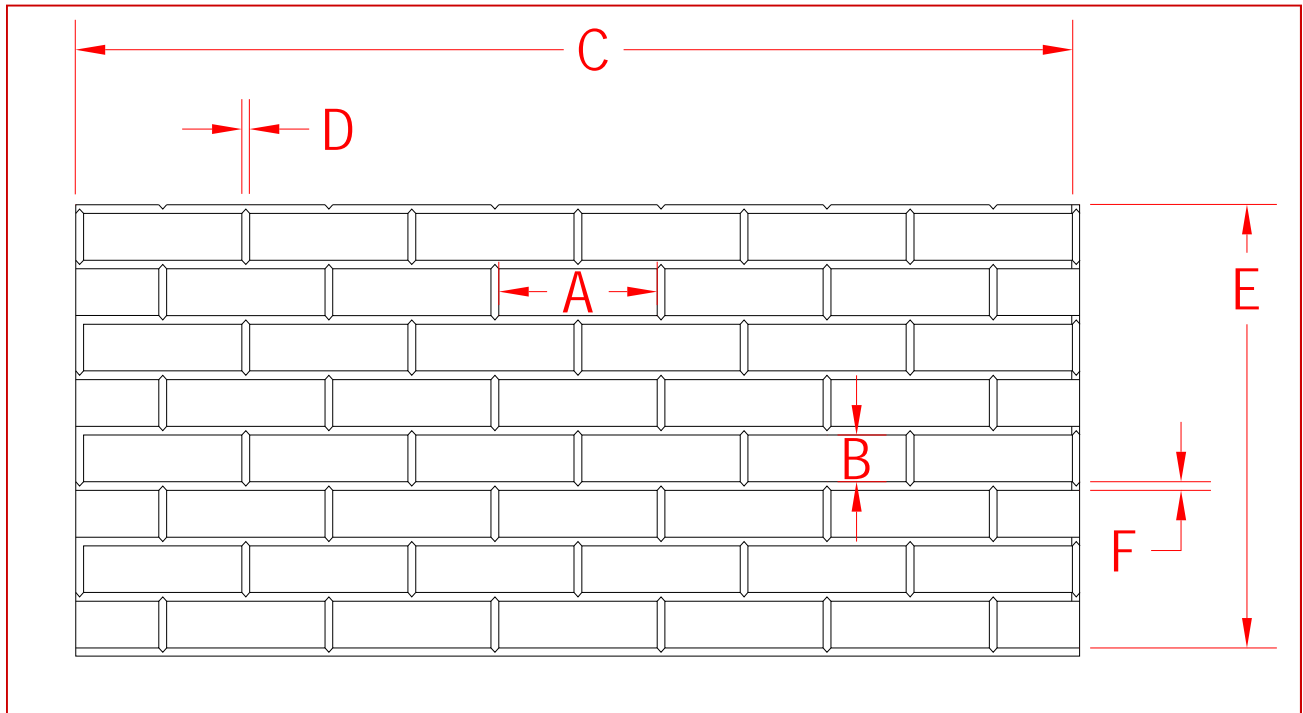

- \*\*CFTJ—“compression fit” textured joint
- Pocket will conform to brick size approx. 7 5/8” - 7 3/4”

**Coverage / Piece**

Square Feet.... 5.92  
Linear Feet..... 3.33

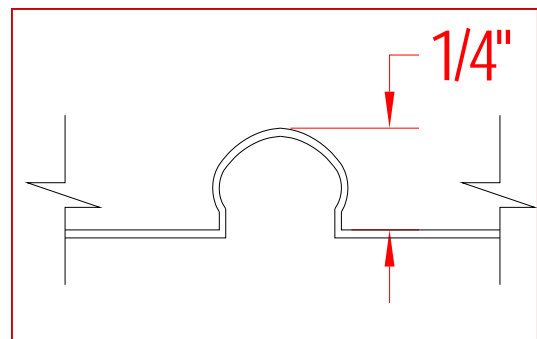

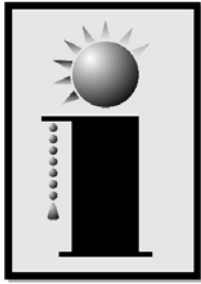

**INNOVATIVE**  
BRICK SYSTEMS, L.L.C.

**Innovative Brick Systems, L.L.C.**  
11625 Reed Ct.  
Broomfield, Co. 80020  
800-413-4588

**VersaLiner®**  
**#100 ECO-CAST**  
**Modular Running Bond**  
*Multi-use*

**Dimensions**

A... 7 5/8"  
B... 2 1/4"  
C...\* 32 3/8"  
D... 3/8"  
E...\* 27.08"  
F... .417"

\* coefficient of thermal expansion .00007 m / °C

Patent Number: D,479,614

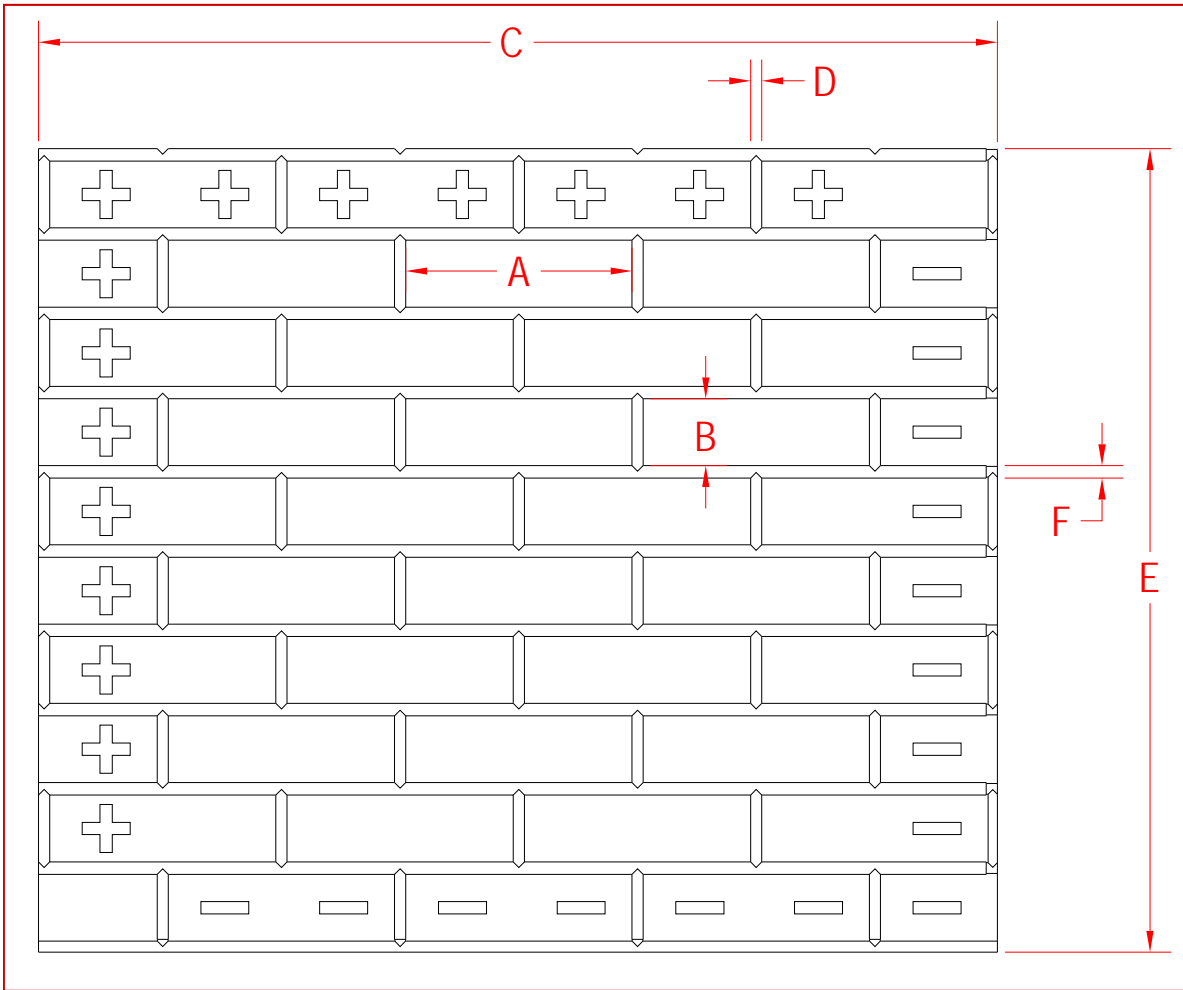

**Coverage / Piece**

Square Feet.... 5.92  
Linear Feet..... 2.66

**Shipping Info**

Box size .. 7"x28"x33"  
Pcs per box .... 50  
Box weight ... 43 lbs  
SF per box .....296

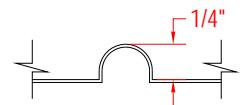

**COVE JOINT**

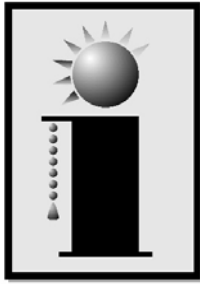

**INNOVATIVE**  
BRICK SYSTEMS, L.L.C.

**Innovative Brick Systems, L.L.C.**  
11625 Reed Ct.  
Broomfield, Co. 80020  
800-413-4588

**VersaLiner®**  
**#100.3/16 Modular Running Bond**  
**Shallow Cove**

Patent Number: D,479,614

**Dimensions**

A... 7 5/8"  
B... 2 1/4"  
C...\* 32"  
D... 3/8"  
E...\* 26.67"  
F... .4166"

\* ±1/8" for normal thermal expansion and contraction

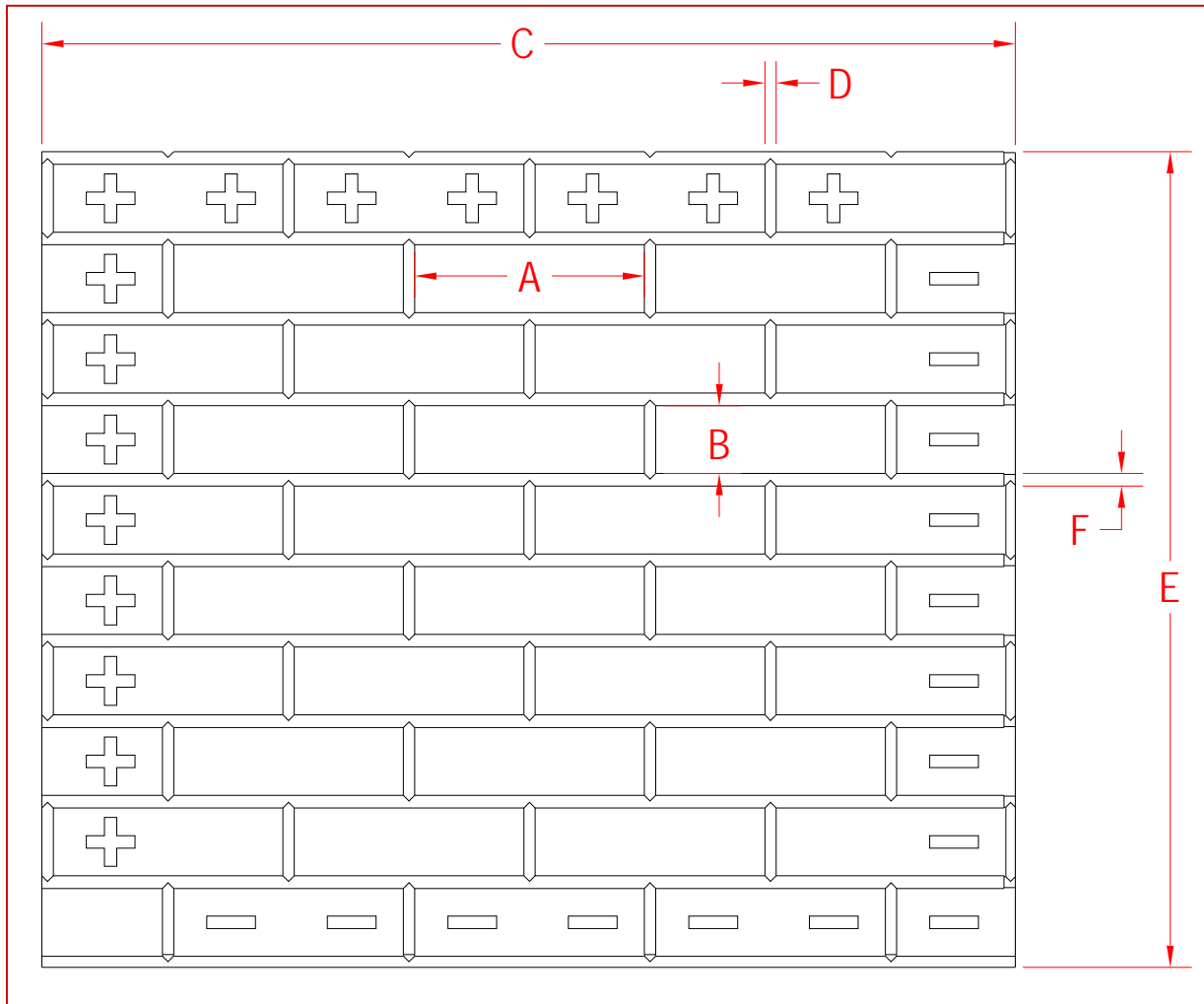

**Coverage / Piece**

Square Feet.... 5.92  
Linear Feet..... 2.66

**Shipping Info**

Box size .. 7"x28"x33"  
Pcs per box .... 50  
Box weight ... 37 lbs  
SF per box .....296

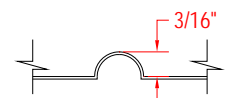

**SHALLOW COVE**  
**JOINT**

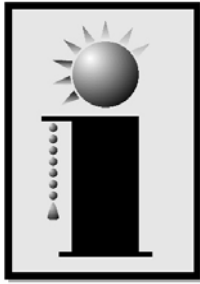

**INNOVATIVE**  
BRICK SYSTEMS, L.L.C.

**Innovative Brick Systems, L.L.C.**  
11625 Reed Ct.  
Broomfield, Co. 80020  
800-413-4588

**VersaLiner®**  
**#103 Modular Running Bond**  
**3/8" Bed Joint**

Patent Number: D,479,614

**Dimensions**

A... 7 5/8"  
B... 2 1/4"  
C...\* 32 3/8"  
D... 3/8"  
E...\* 26 5/8"  
F... 3/8"

\* ±1/8" for normal thermal expansion and contraction

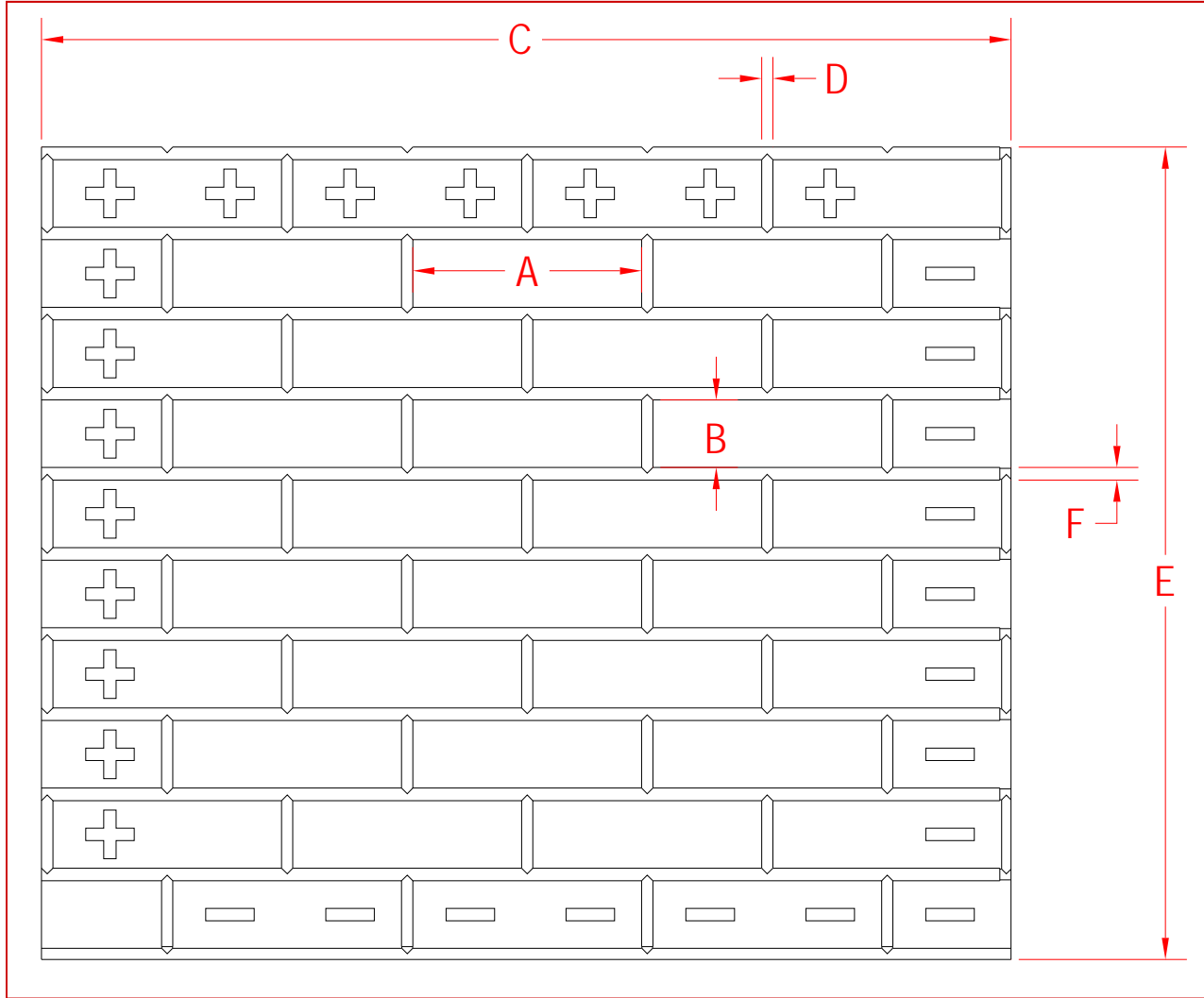

**Coverage / Piece**

Square Feet.... 5.92  
Linear Feet..... 2.66

**Shipping Info**

Box size .. 7"x28"x33"  
Pcs per box .... 50  
Box weight ... 37 lbs  
SF per box .....296

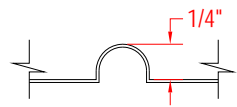

**COVE JOINT**

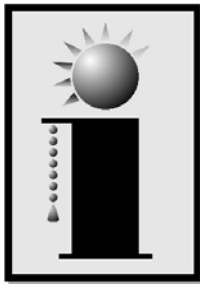

**INNOVATIVE**  
BRICK SYSTEMS, L.L.C.

**Innovative Brick Systems, L.L.C.**  
11625 Reed Ct.  
Broomfield, Co. 80020  
800-413-4588

**VersaLiner®**  
**#104 Modular Running Bond**  
**Molded Coped Return**

**Dimensions**

A... 7 5/8"  
B... 2 1/4"  
C...\* 7 5/8"  
D... 3/8"  
E...\* 42.7"  
F... .417"

\* ±1/8" for normal thermal expansion and contraction

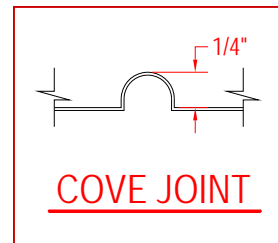
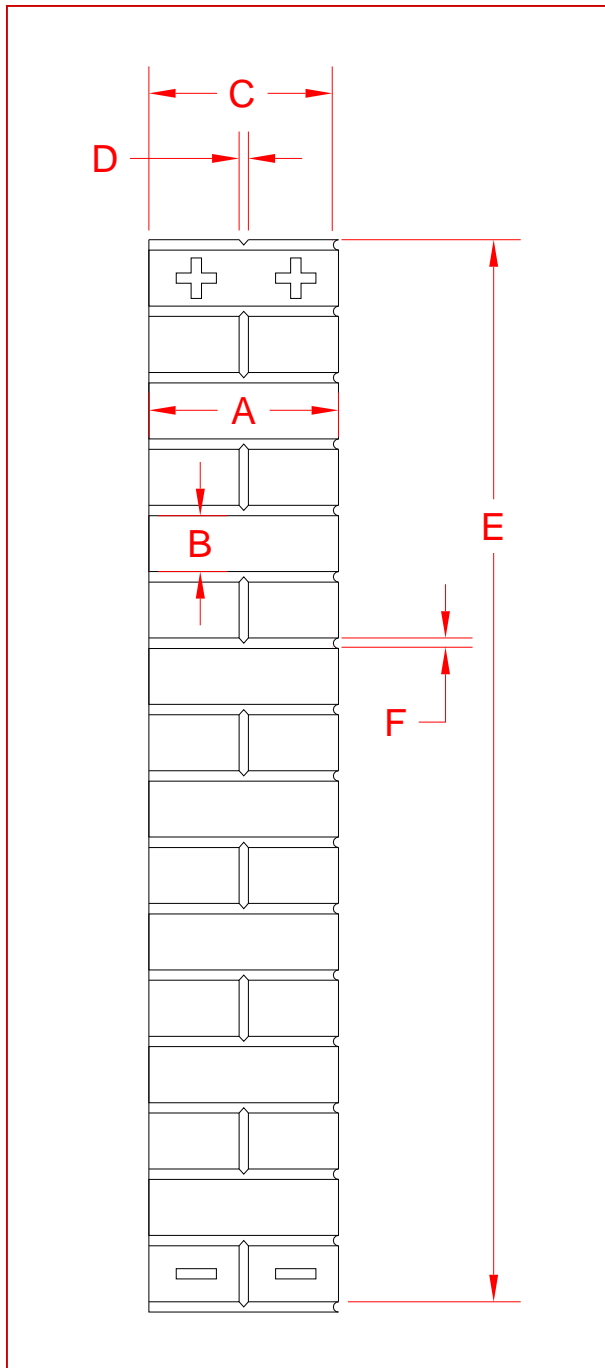

<b><u>Coverage / Piece</u></b>	
Square Feet....	2.67
Linear Feet....	3.56



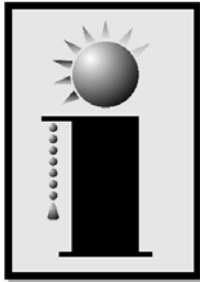

**INNOVATIVE**  
BRICK SYSTEMS, L.L.C.

**Innovative Brick Systems, L.L.C.**  
11625 Reed Ct.  
Broomfield, Co. 80020  
800-413-4588

**VersaLiner®**  
**#105.1 Modular Running Bond**  
**Grapevine Joint**

Patent Number: D,479,614

**Dimensions**

A... 7 5/8"  
B... 2 1/4"  
C...\* 40"  
D... 3/8"  
E...\* 21.33"  
F... .417"

\* ±1/8" for normal thermal expansion and contraction

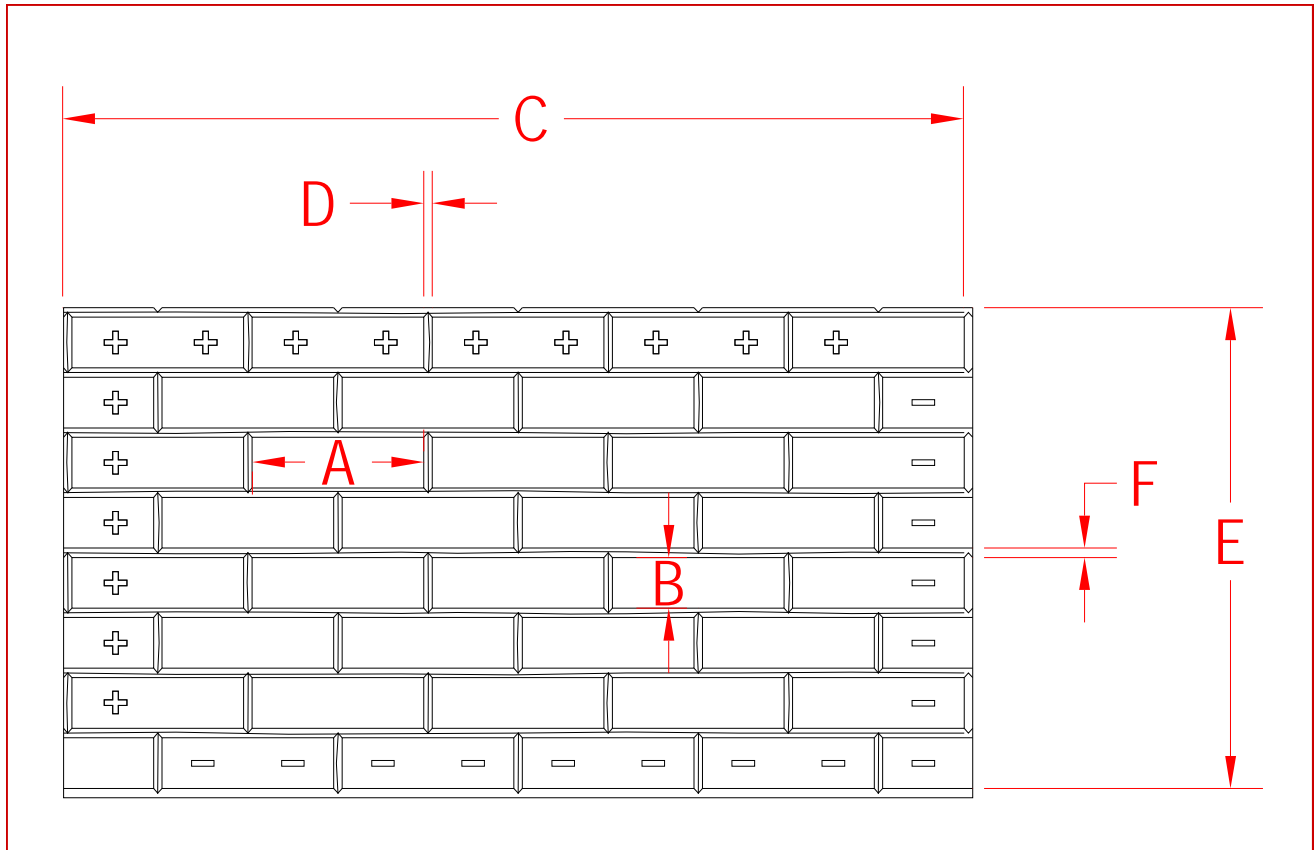

<b><u>Coverage / Piece</u></b>	
Square Feet....	5.92
Linear Feet.....	3.33

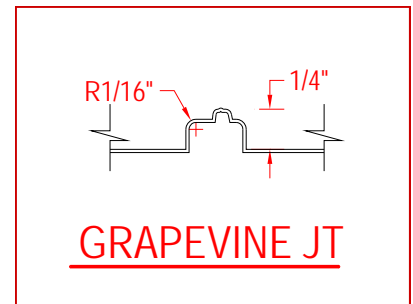

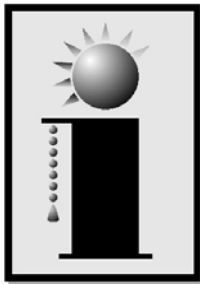

**INNOVATIVE**  
BRICK SYSTEMS, L.L.C.

Innovative Brick Systems, L.L.C.  
11625 Reed Ct.  
Broomfield, Co. 80020  
800-413-4588

**VersaLiner®**  
**#106 Modular Return**  
**Coped 7 5/8"**

**Dimensions**

A... 3 5/8"  
B... 2 1/4"  
C...\* 7 5/8"  
D... 3/8"  
E...\* 26 2/3"  
F... .4166"

\* ±1/8" for normal thermal expansion and contraction

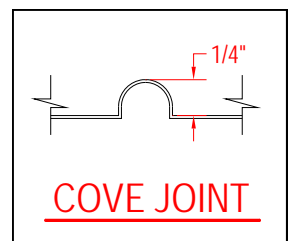
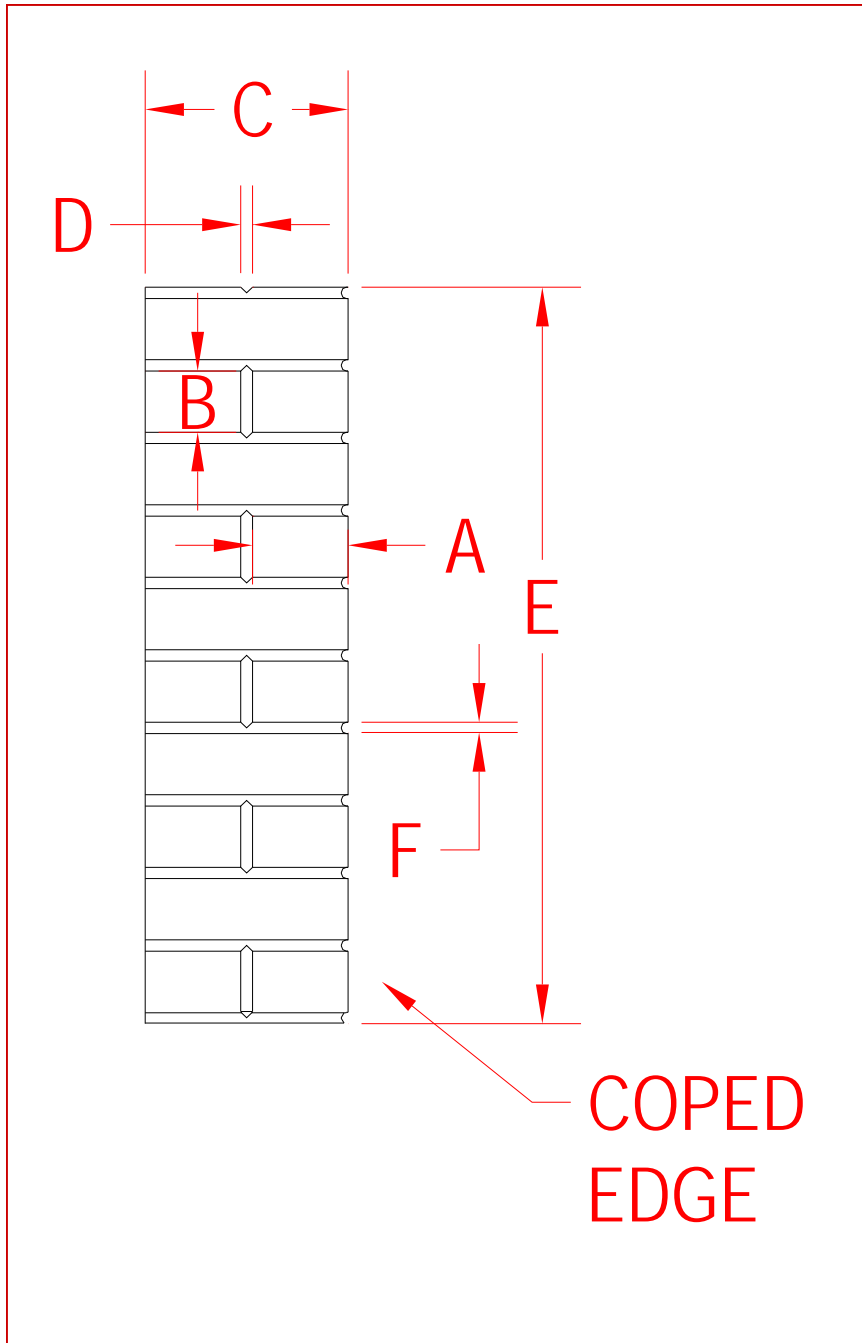

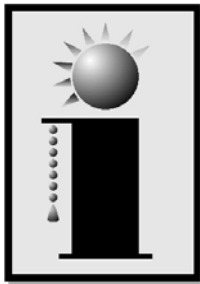

**INNOVATIVE**  
BRICK SYSTEMS, L.L.C.

Innovative Brick Systems, L.L.C.  
11625 Reed Ct.  
Broomfield, Co. 80020  
800-413-4588

**VersaLiner®**  
**#107 Modular Return**  
**Coped 3 5/8"**

**Dimensions**

A... 3 5/8"  
B... 2 1/4"  
C...\* 3 5/8"  
D...  
E...\* 26 2/3"  
F... .4166"

\* ±1/8" for normal thermal expansion and contraction

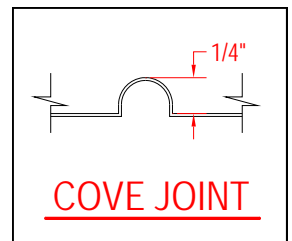
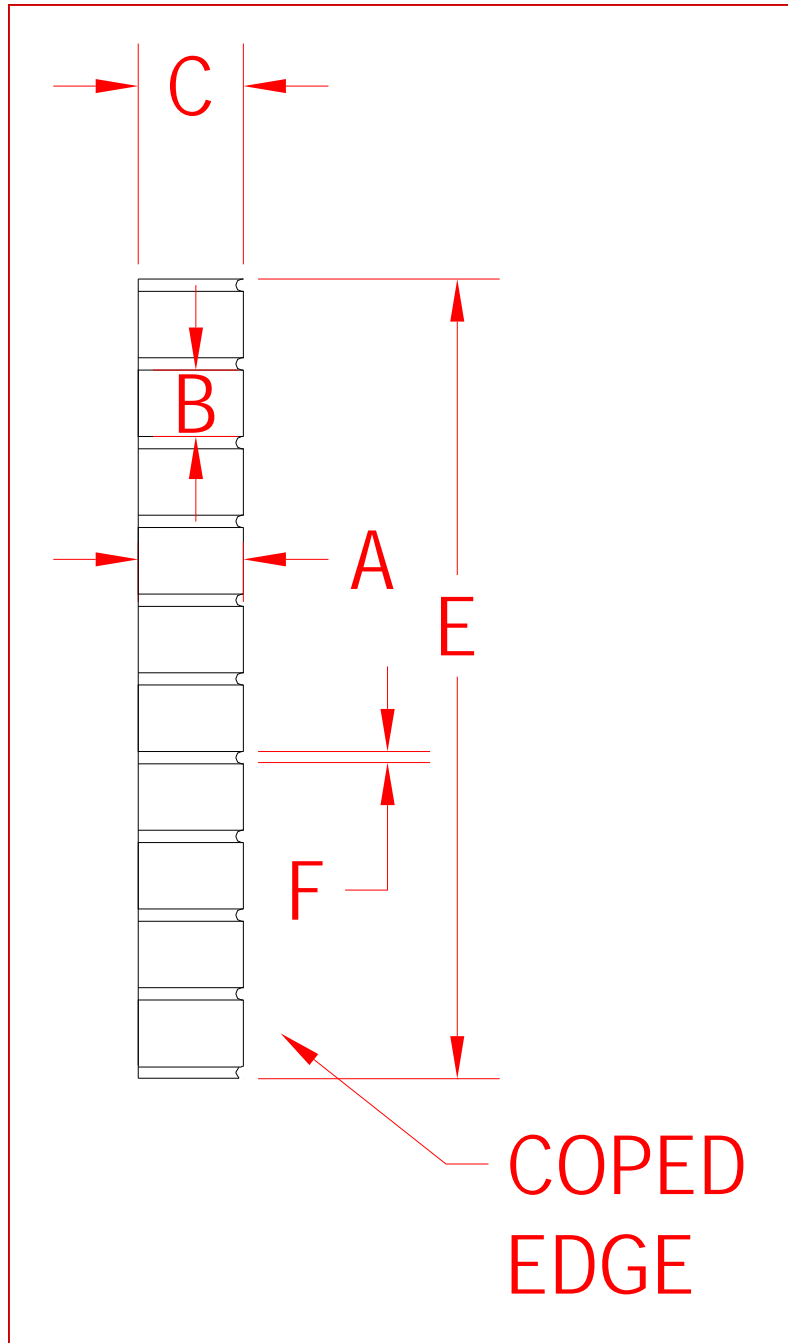

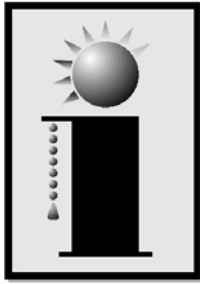

**INNOVATIVE**  
BRICK SYSTEMS, L.L.C.

Innovative Brick Systems, L.L.C.  
11625 Reed Ct.  
Broomfield, Co. 80020  
800-413-4588

**VersaLiner®**  
**#109 Modular Return 7 5/8"**  
**Coped / Boot**

**Dimensions**

A... 7 5/8"  
B... 2 1/4"  
C...\* 7 5/8"  
D... 3/8"  
E...\* 42 5/8"  
F... .4166"

\* ±1/8" for normal thermal expansion and contraction

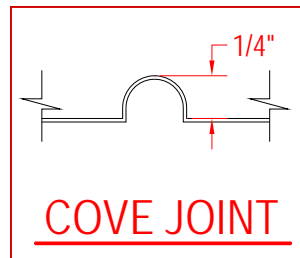
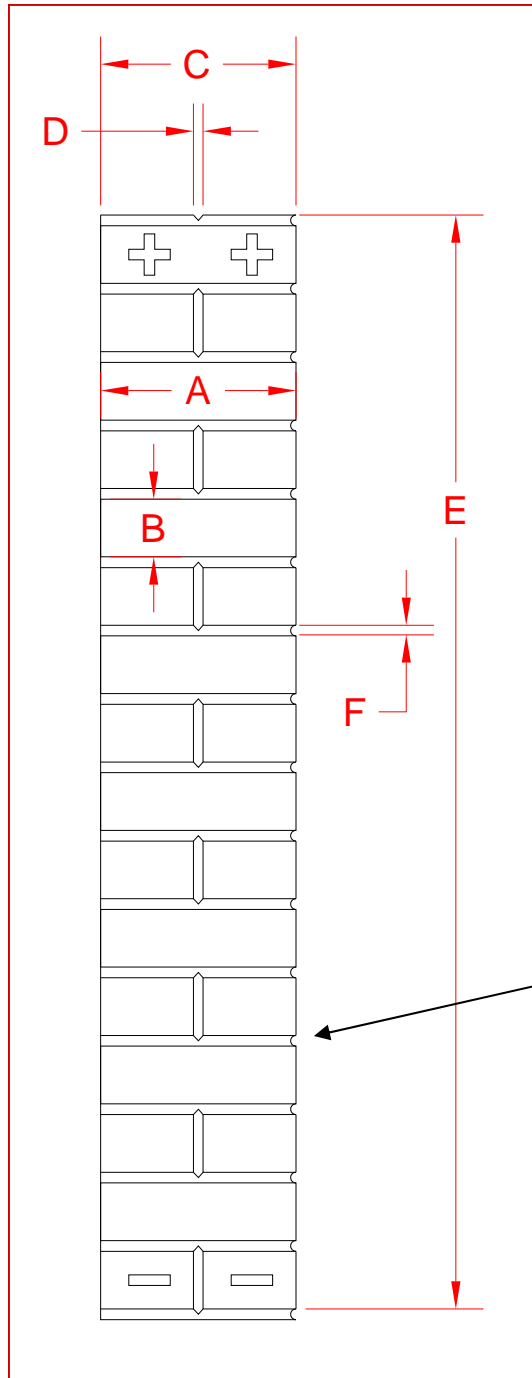

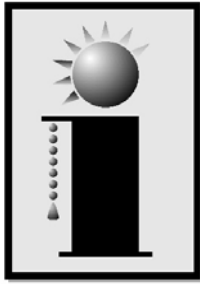

**INNOVATIVE**  
BRICK SYSTEMS, L.L.C.

**Innovative Brick Systems, L.L.C.**  
11625 Reed Ct.  
Broomfield, Co. 80020  
800-413-4588

**VersaLiner®**  
**#115 Modular Folding Corner**  
**Running Bond**

**Dimensions**

A... 7 5/8"  
B... 2 1/4"  
C...\* 16"  
D... 3/8"  
E...\* 26 5/8"  
F... .417"

\* ±1/8" for normal thermal expansion and contraction

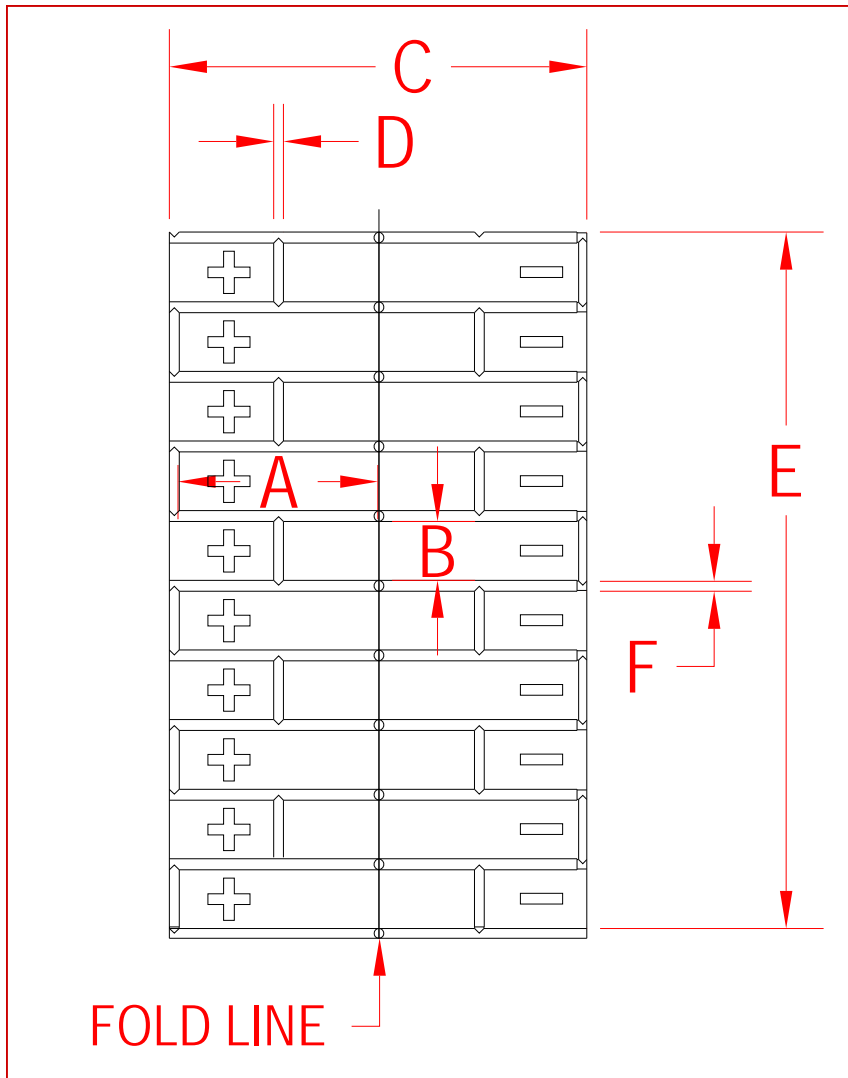

**Coverage / Piece**

Square Feet.... 2.96  
Linear Feet..... 2.22

**Shipping Info**

Box size .. 7"x28"x33"  
Pcs per box .... 100  
Box weight ... 37 lbs  
SF per box .....296

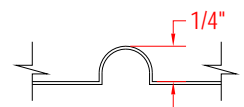

**COVE JOINT**

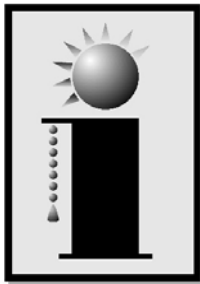

**INNOVATIVE**  
BRICK SYSTEMS, L.L.C.

Innovative Brick Systems, L.L.C.  
11625 Reed Ct.  
Broomfield, Co. 80020  
800-413-4588

**VersaLiner®**  
**#117 Modular Running Bond**  
**Folding Corner—Long**

**Dimensions**

- A... 7 5/8"
- B... 2 1/4"
- C...\* 16"
- D... 3/8"
- E...\* 42 11/16"
- F... .417"

\* ±1/8" for normal thermal expansion and contraction

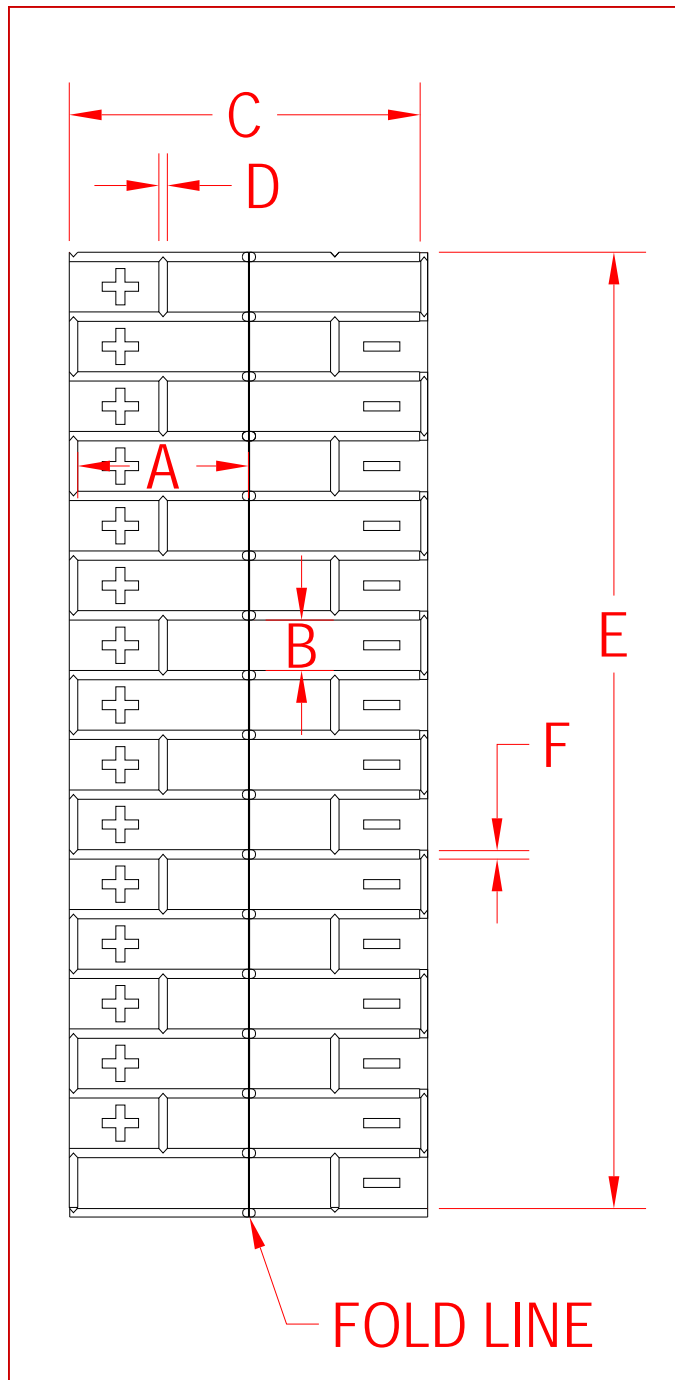

**Coverage / Piece**

Square Feet.... 4.74  
Linear Feet..... 3.56

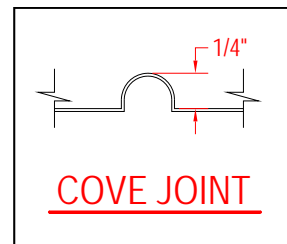

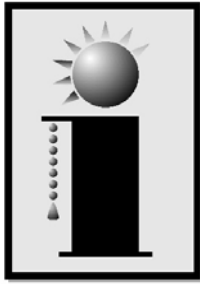

**INNOVATIVE**  
BRICK SYSTEMS, L.L.C.

Innovative Brick Systems, L.L.C.  
11625 Reed Ct.  
Broomfield, Co. 80020  
800-413-4588

## VersaLiner® #120 Modular Stack Bond Single Row

### Dimensions

A... 7 5/8"  
B... 2 1/4"  
C...\* 8"  
D... 3/8"  
E...\* 26.66"  
F... .4166"

\* ±1/8" for normal thermal expansion and contraction

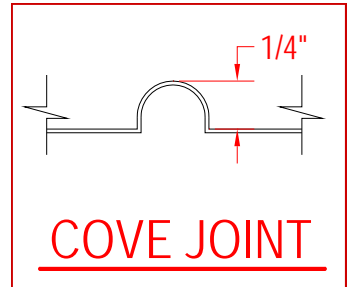
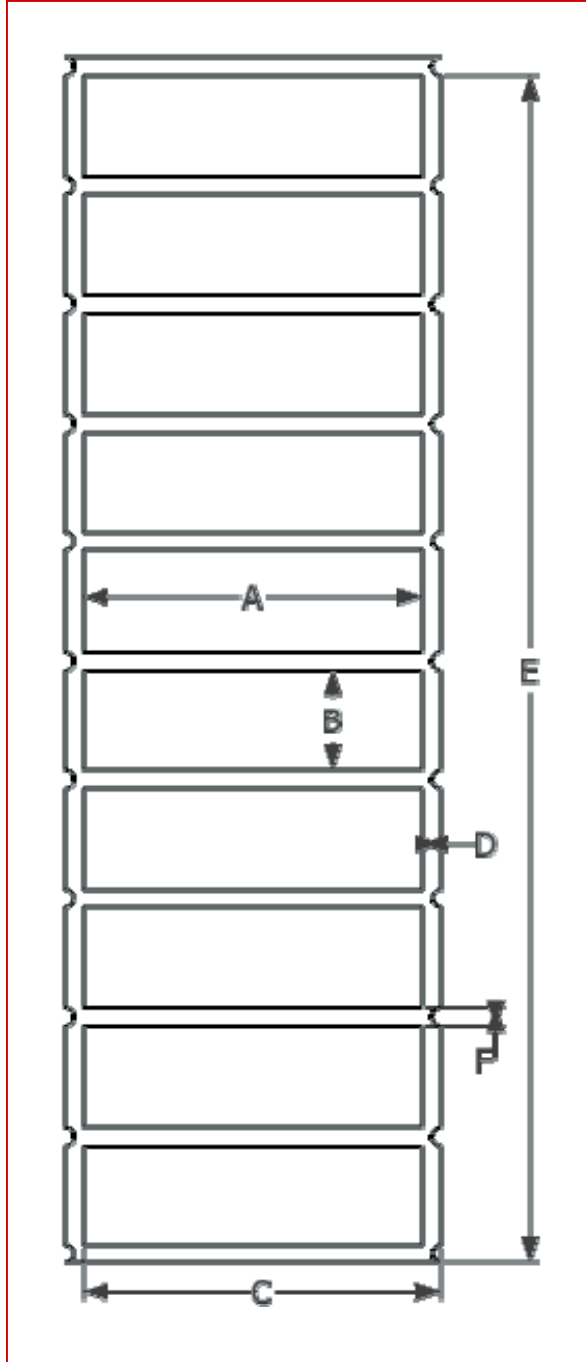

### Coverage / Piece

Square Feet.... 5.92  
Linear Feet..... 2.66



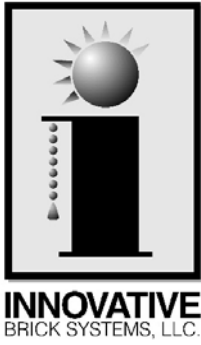

Innovative Brick Systems, L.L.C.  
11625 Reed Ct.  
Broomfield, Co. 80020  
800-413-4588

**VersaLiner®**  
**#121 Modular Soldier**  
**Grapevine Joint - Offset**

**Dimensions**

- A... 7 5/8"
- B... 2 1/4"
- C...\* 8"
- D... 3/8"
- E...\* 32"
- F... .417"

\* ±1/8" for normal thermal expansion and contraction

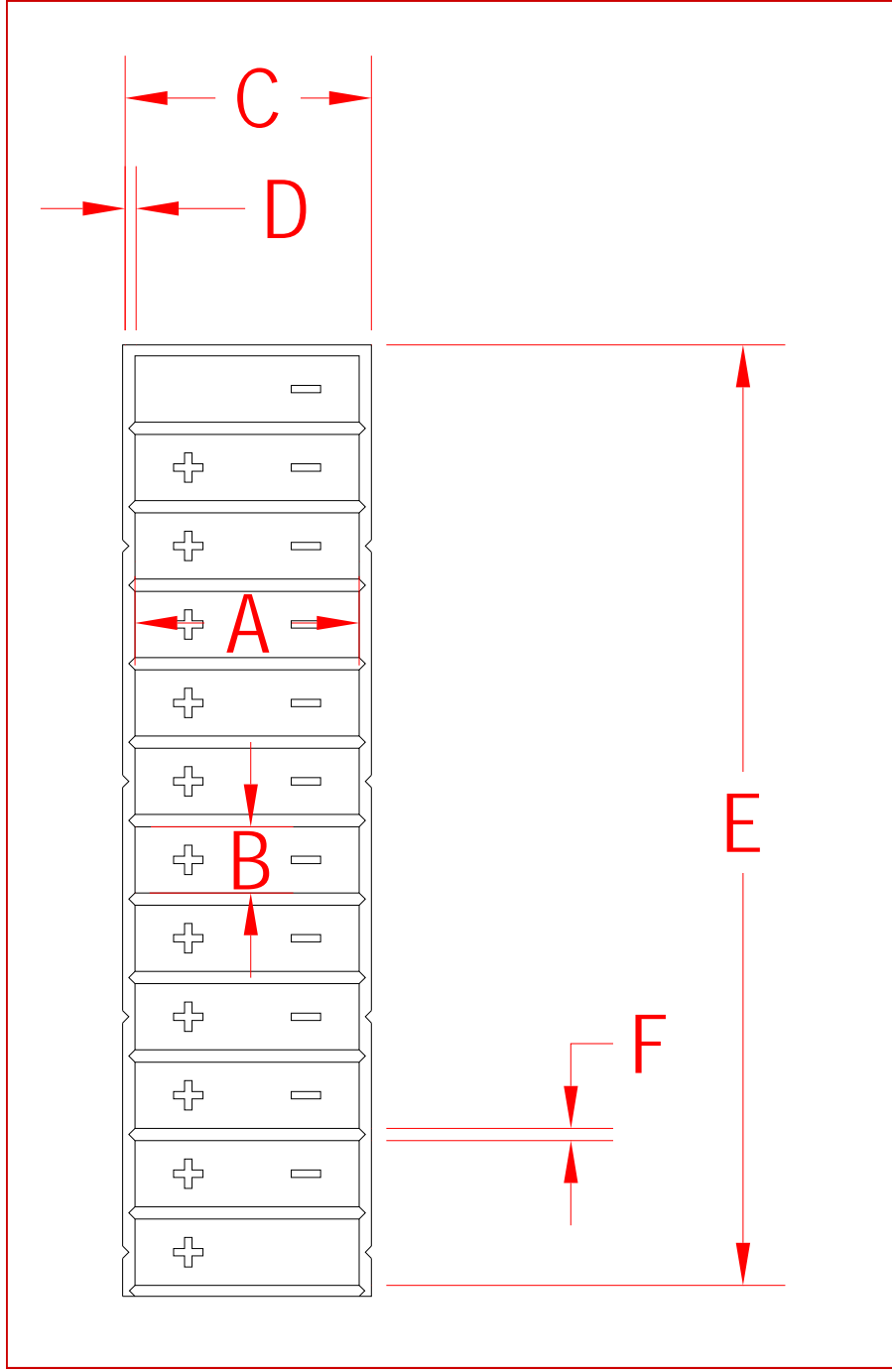

**Coverage / Piece**

Square Feet... 1.78  
Linear Feet..... 2.67

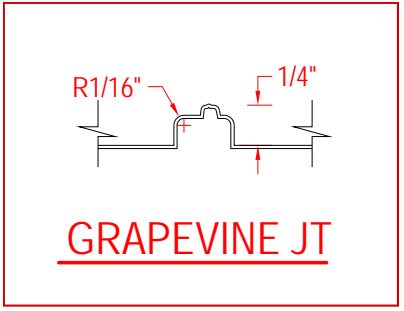

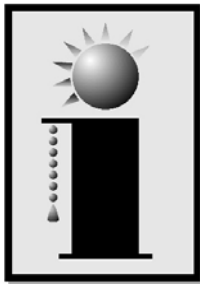

**INNOVATIVE**  
BRICK SYSTEMS, L.L.C.

**Innovative Brick Systems, L.L.C.**  
11625 Reed Ct.  
Broomfield, Co. 80020  
800-413-4588

**VersaLiner®**  
**#124 Modular**  
**Half Stretchers**

**Dimensions**

A... 3 5/8"  
B... 2 1/4"  
C...\* 32 3/8"  
D... 3/8"  
E...\* 5.33"  
F... .417"

\* ±1/8" for normal thermal expansion and contraction

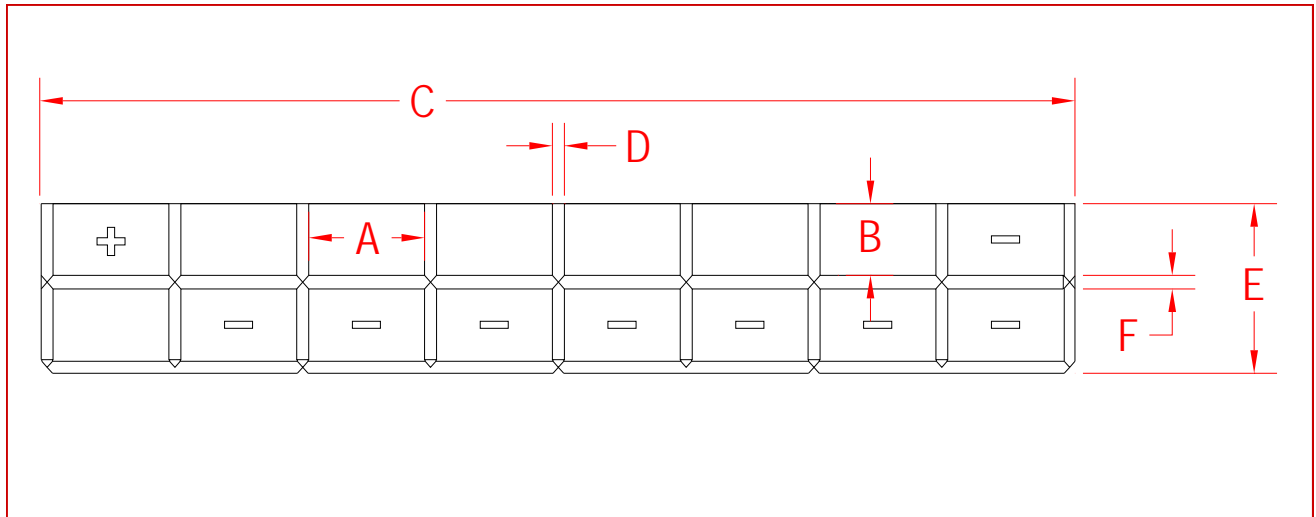

**Finished Pattern (yellow)**

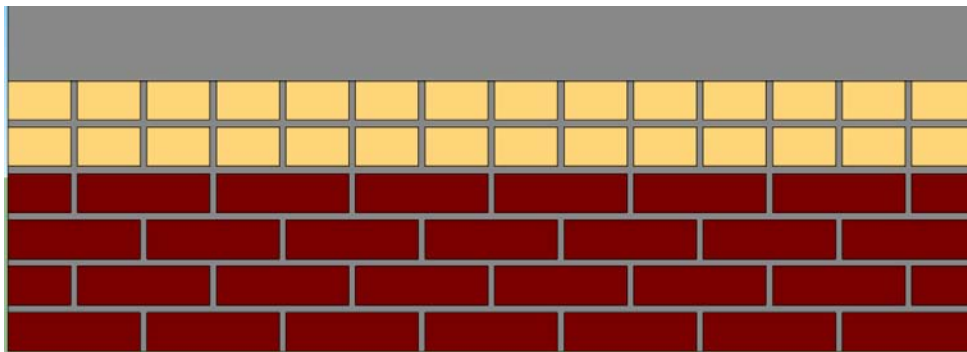

**Coverage / Piece**

Square Feet.... 1.1  
Linear Feet..... 2.7

**Shipping Info**

Box size .. 7"x28"x33"  
Pcs per box ....  
Box weight ...  
SF per box .....

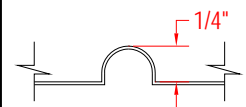

**COVE JOINT**

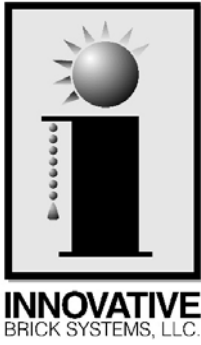

Innovative Brick Systems, L.L.C.  
11625 Reed Ct.  
Broomfield, Co. 80020  
800-413-4588

**Dimensions**  
 A... 2 1/4"  
 B... 7 5/8"  
 C...\* 40"  
 D... .417"  
 E...\* 24"  
 F... 3/8"  
 \* ±1/8" for normal thermal expansion and contraction

**VersaLiner®**  
**#125- 3x CFTJ\***  
**Modular 3x Soldier**

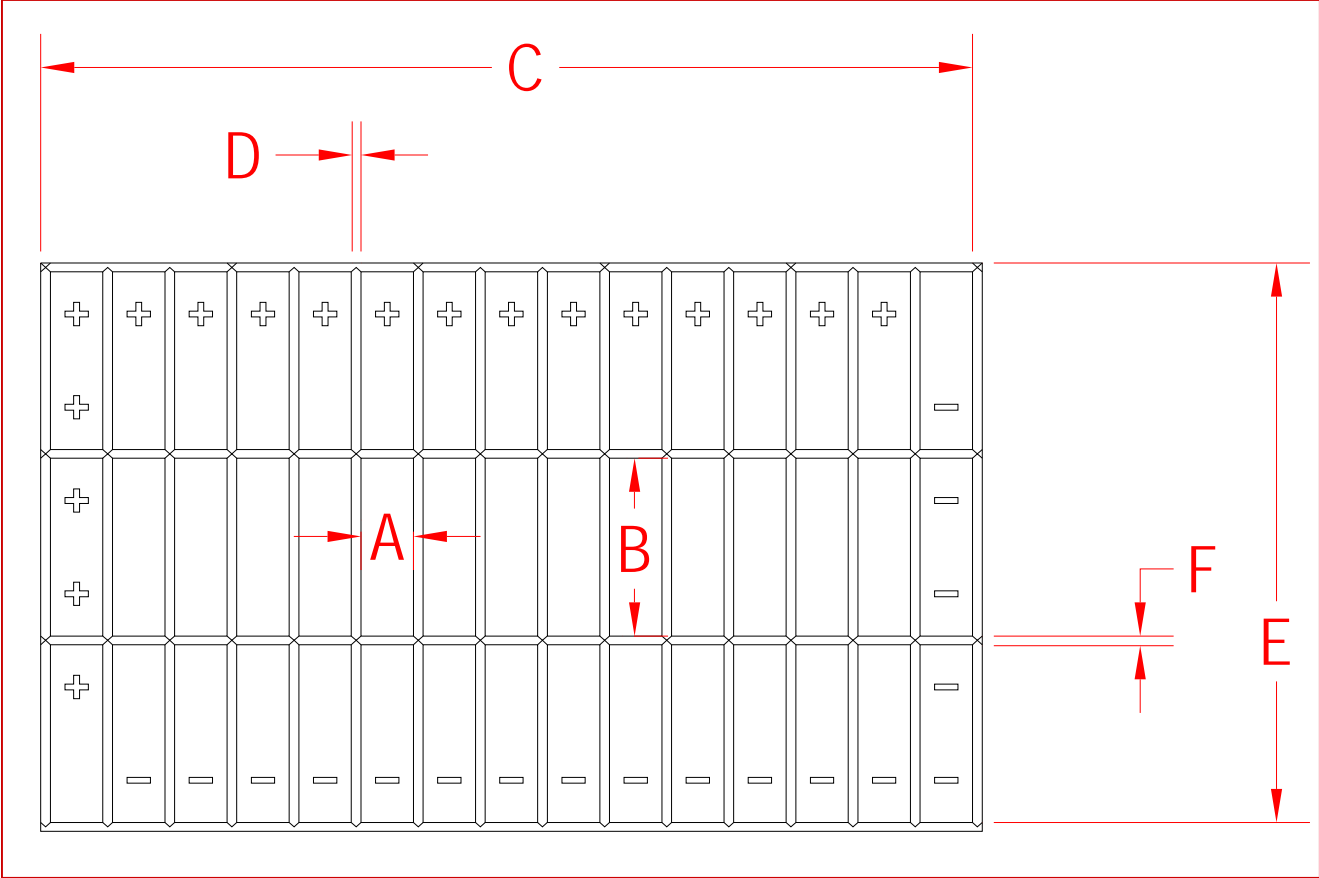

\* CFTJ—joint is “compression fit” textured joint.

<b><u>Coverage / Piece</u></b>	
Square Feet....	6.67
Linear Feet.....	3.33

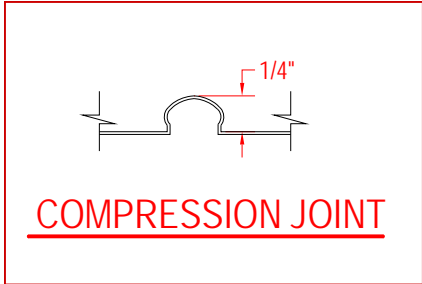

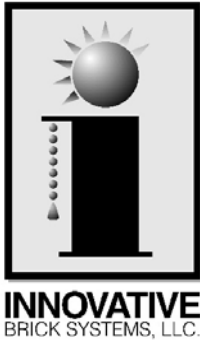

Innovative Brick Systems, L.L.C.  
11625 Reed Ct.  
Broomfield, Co. 80020  
800-413-4588

**Dimensions**  
 A... 2 1/4"  
 B... 7 5/8"  
 C...\* 8 3/8"  
 D... 3/8"  
 E...\* 32 3/8"  
 F... .4167

\* ±1/8" for normal thermal expansion and contraction

**VersaLiner®**  
**#125 B Modular**  
**Soldier Course (offset)**

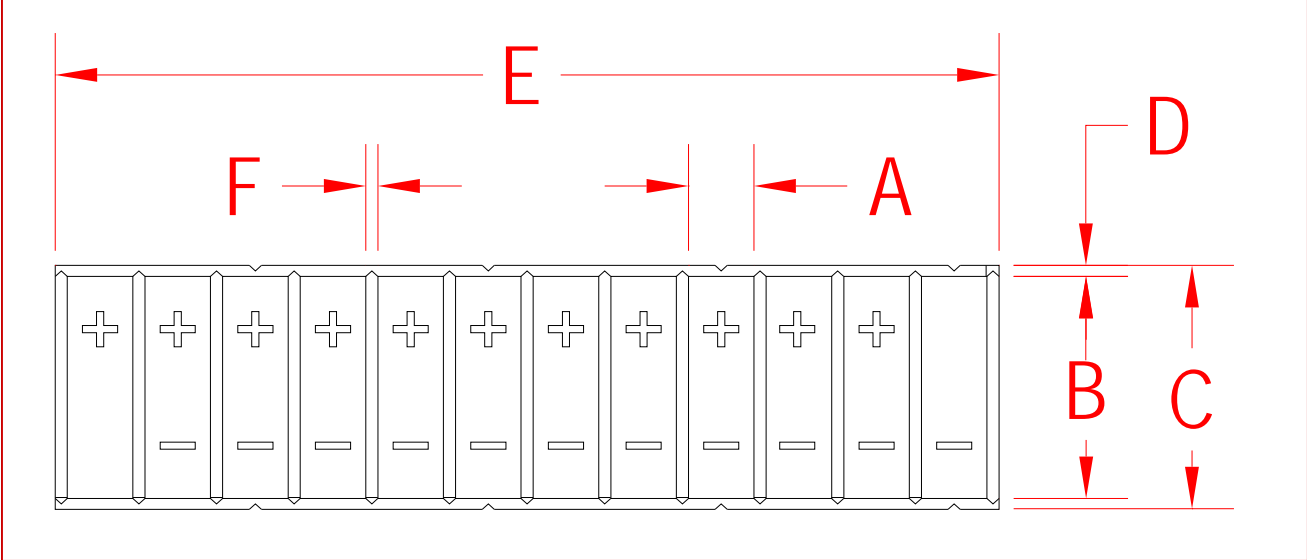

Finished Pattern (yellow)

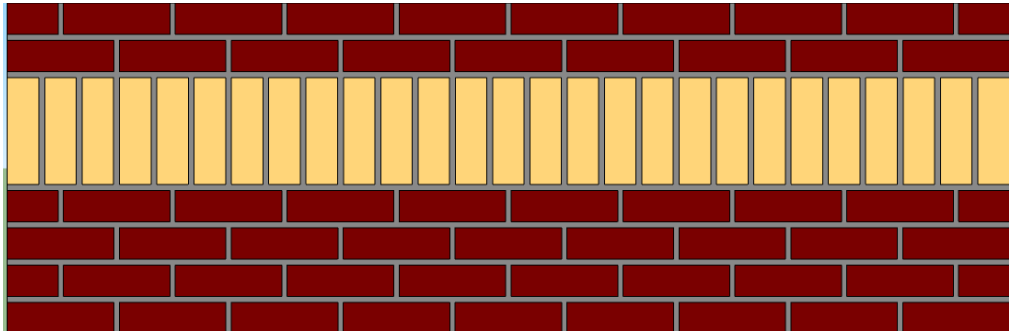

<b><u>Coverage / Piece</u></b>	
Square Feet....	1.78
Linear Feet.....	2.66

<b><u>Shipping Info</u></b>	
Box size ..	7"x28"x33"
Pcs per box	.... 150
Box weight	... 37 lbs
SF per box	.....267

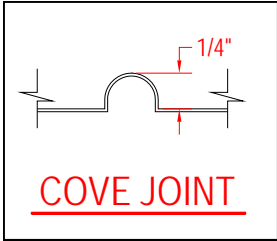

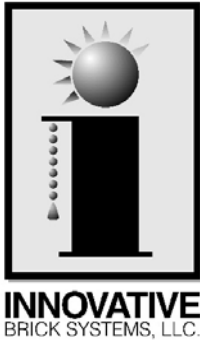

Innovative Brick Systems, L.L.C.  
11625 Reed Ct.  
Broomfield, Co. 80020  
800-413-4588

**Dimensions**  
 A... 2 1/4"  
 B... 7 5/8"  
 C...\* 48"  
 D... .417"  
 E...\* 8"N  
 F... 3/8"N  
 \* ±1/8" for normal thermal expansion and contraction

**VersaLiner®**  
**#125.01 Modular Stack Bond**  
**Single Row**

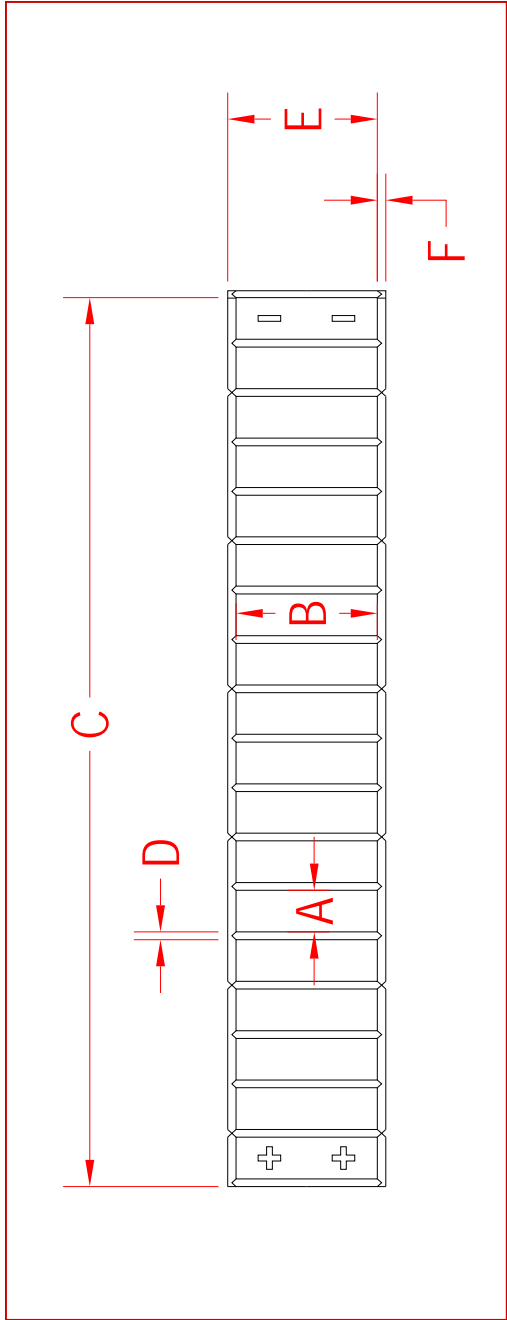

Joint is compression joint  
with texture

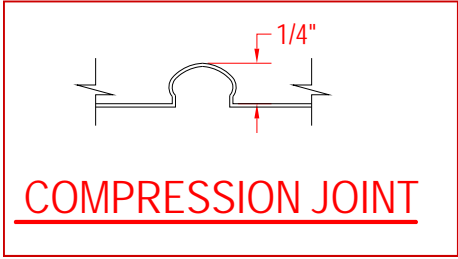

**Coverage / Piece**

Square Feet.... 3  
 Linear Feet..... 4



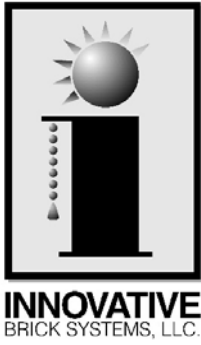

Innovative Brick Systems, L.L.C.  
11625 Reed Ct.  
Broomfield, Co. 80020  
800-413-4588

**Dimensions**  
 A... 7 5/8"  
 B... 2 1/4"  
 C...\* 8"  
 D... 3/8"  
 E...\* 40"  
 F... .417"  
 \* ±1/8" for normal thermal expansion and contraction

**VersaLiner®  
#127 Modular Soldier  
No Saddles**

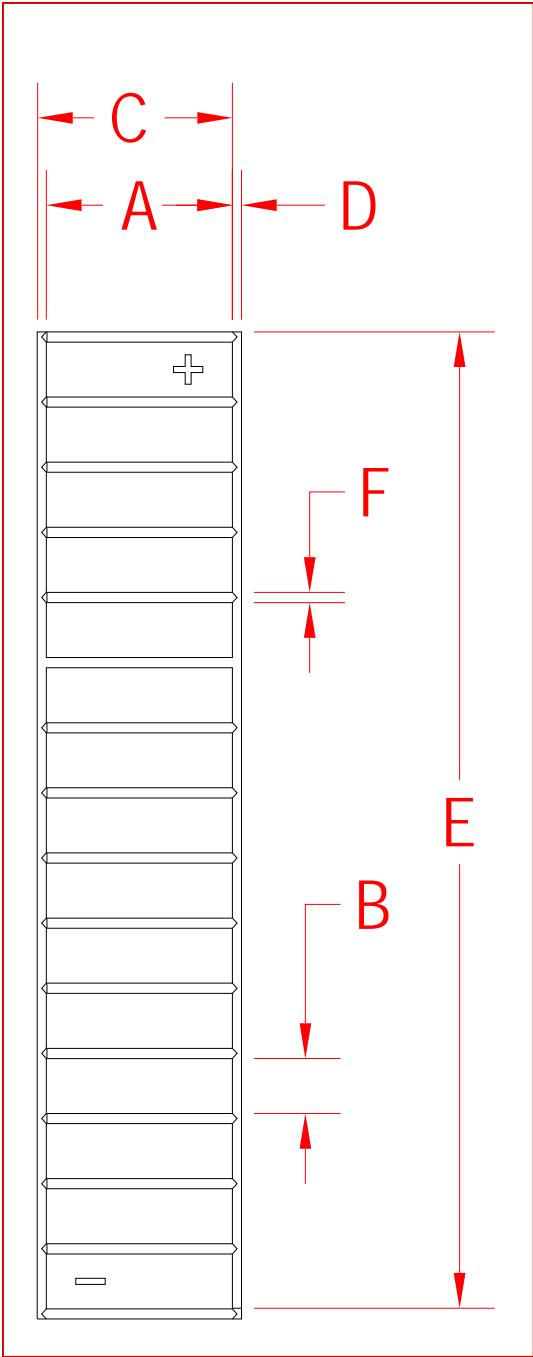

**Coverage / Piece**  
 Square Feet... 2.22  
 Linear Feet.... 3.33

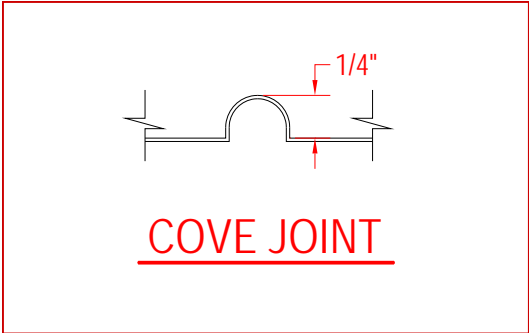

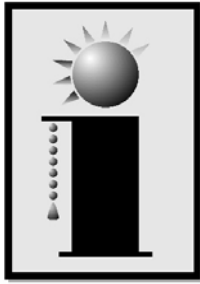

**INNOVATIVE**  
BRICK SYSTEMS, L.L.C.

Innovative Brick Systems, L.L.C.  
11625 Reed Ct.  
Broomfield, Co. 80020  
800-413-4588

**VersaLiner®**  
**#138 Modular Stretcher Course**  
**Recessed 1/2", No Saddles**

**Dimensions**

- A... 7 5/8"
- B... .2 1/4"
- C...\* 40"
- D... 3/8"
- E...\* 2.67"
- F... .417"

\* ±1/8" for normal thermal expansion and contraction

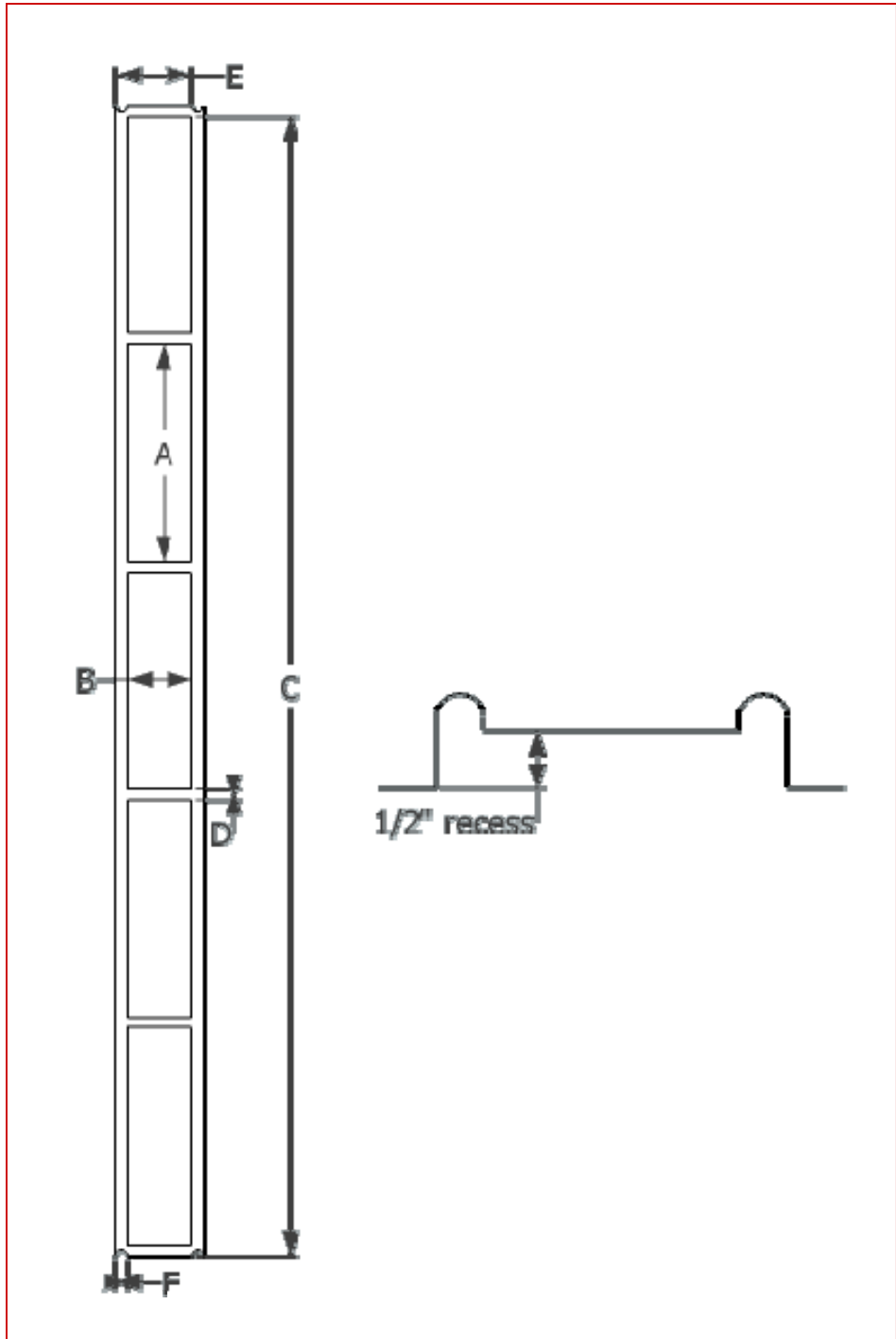

**Coverage / Piece**

Square Feet.... .74  
Linear Feet.... 3.33

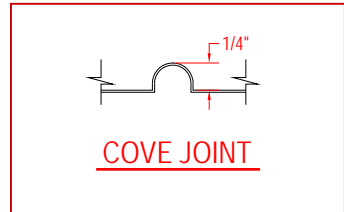

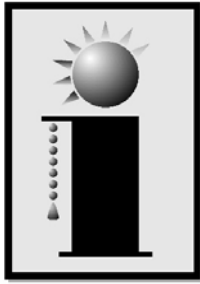

**INNOVATIVE**  
BRICK SYSTEMS, L.L.C.

**Innovative Brick Systems, L.L.C.**  
11625 Reed Ct.  
Broomfield, Co. 80020  
800-413-4588

**VersaLiner®**  
**#141 Flemish Bond**  
**Every Row**

**Dimensions**

A... 7 5/8"  
B... 2 1/4"  
C...\* 36 3/8"  
D... 3/8"  
E...\* 27.083"  
F... .4166"

\* ±1/8" for normal thermal expansion and contraction

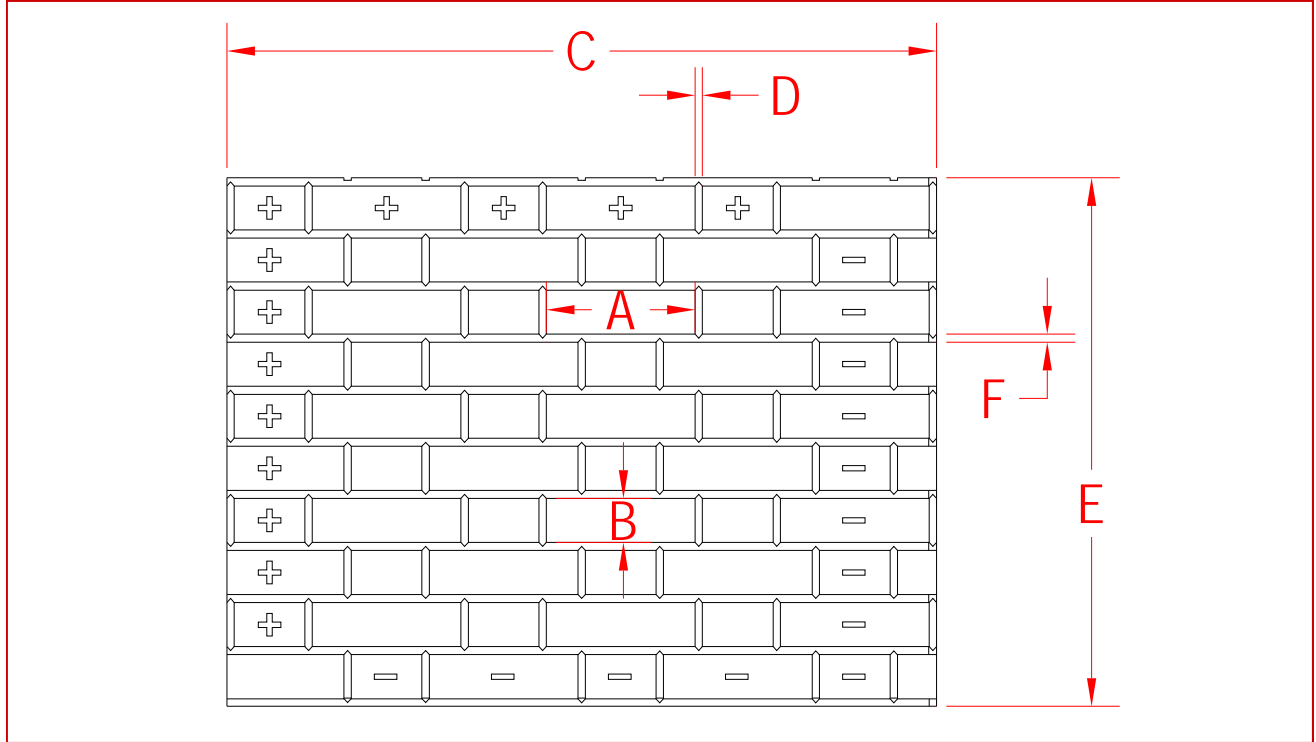

Finished Pattern (2 colors shown)

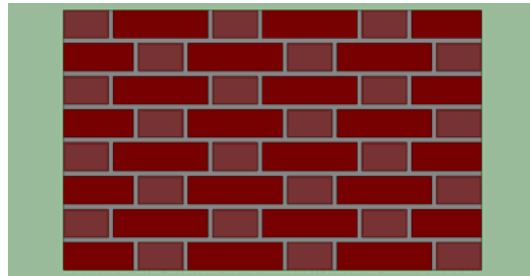

**Coverage / Piece**

Square Feet.... 6.84  
Linear Feet..... 3

**Patent Number: D,479,614**

**Shipping Info**

Box size .. 7"x28"x37"  
Pcs per box .... 50  
Box weight ... 40 lbs  
SF per box .....342

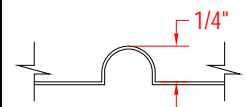

**COVE JOINT**

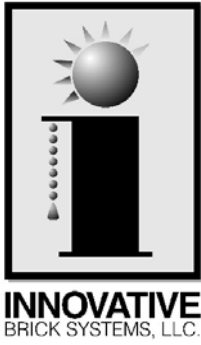

Innovative Brick Systems, L.L.C.  
 11625 Reed Ct.  
 Broomfield, Co. 80020  
 800-413-4588

**Dimensions**  
 A... 7 5/8"  
 B... 2 1/4"  
 C...\* 48"  
 D... 3/8"  
 E...\* 21.33"  
 F... .417"  
 \* ±1/8" for normal thermal expansion and contraction

**VersaLiner®**  
**#152 Modular Rough Brick**  
**Running Bond**

Patent Number: D,479,614

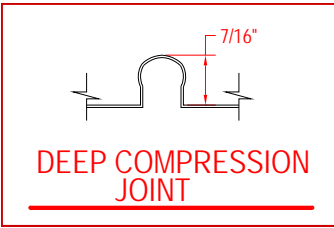
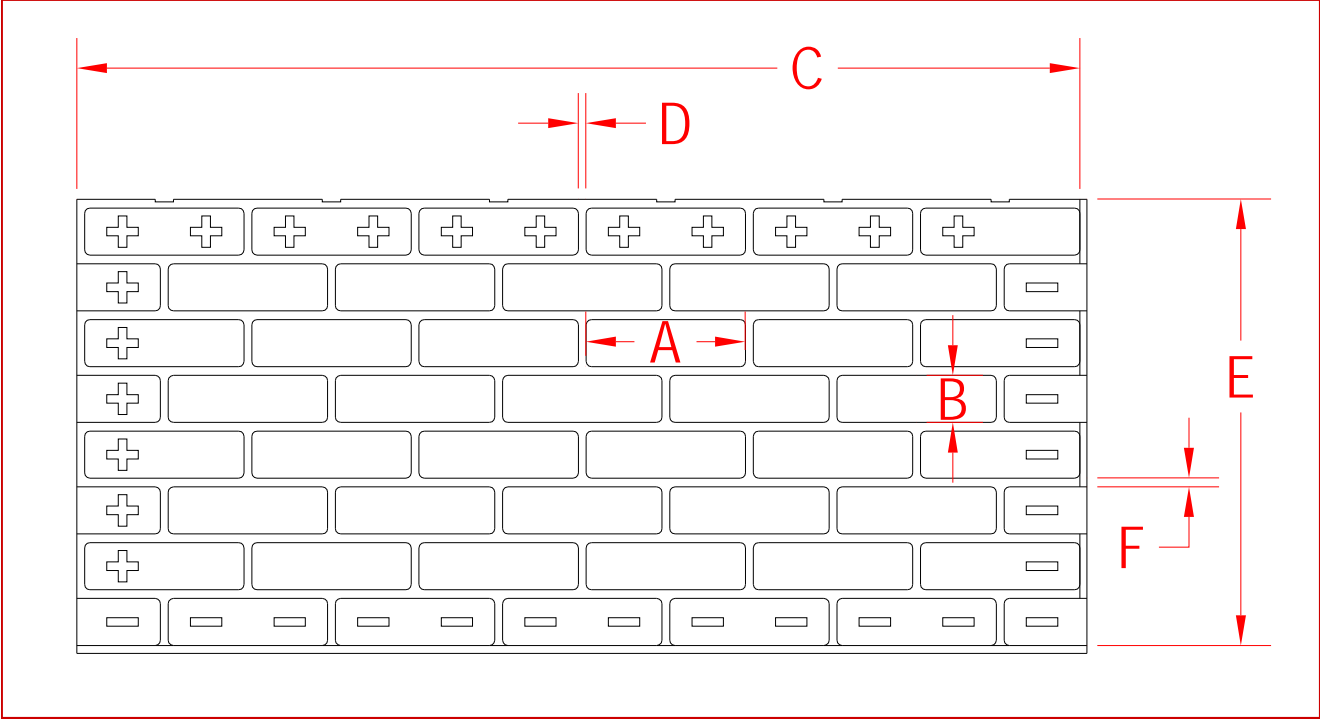

Compression Joint On  
 Head Joint Only

**Coverage / Piece**  
 Square Feet... 7.11  
 Linear Feet.... 4



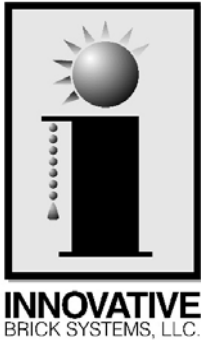

Innovative Brick Systems, L.L.C.  
 11625 Reed Ct.  
 Broomfield, Co. 80020  
 800-413-4588

**Dimensions**  
 A... 7 5/8"  
 B... 2 1/4"  
 C...\* 39 13/16"  
 D... .328"  
 E...\* 27 1/3"  
 F... .417"  
 \* ±1/8" for normal thermal expansion and contraction

**VersaLiner®**  
**#161L Modular RB**  
**-3/16" Starter Left Side**

Patent Number: D,479,614

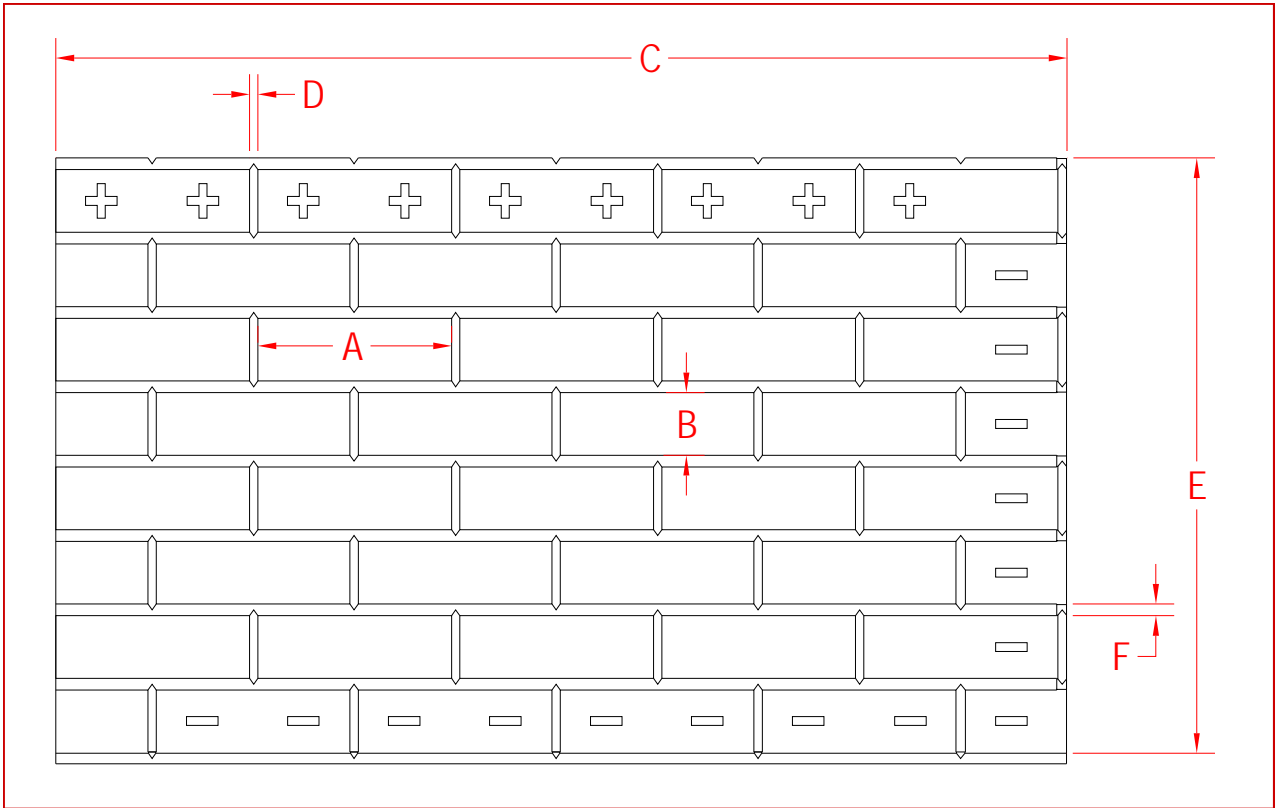

**Coverage / Piece**

Square Feet.... 7.56  
 Linear Feet..... 3.32

**Shipping Info**

Box size .. 7"x28"x40"  
 Pcs per box .... 50  
 Box weight ... 48 lbs  
 SF per box ... 378

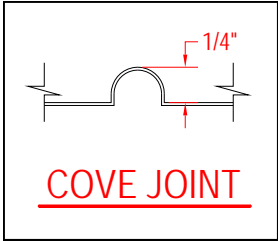

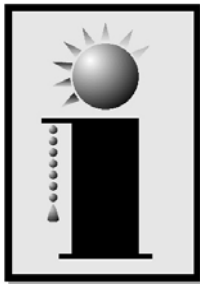

**INNOVATIVE**  
BRICK SYSTEMS, L.L.C.

**Innovative Brick Systems, L.L.C.**  
11625 Reed Ct.  
Broomfield, Co. 80020  
800-413-4588

**VersaLiner®**  
**#161R Modular RB**  
**-3/16" Starter Right Side**

Patent Number: D,479,614

**Dimensions**

A... 7 5/8"  
B... 2 1/4"  
C...\* 39 13/16"  
D... .328  
E...\* 27 1/3"  
F... .417"

\* ±1/8" for normal thermal expansion and contraction

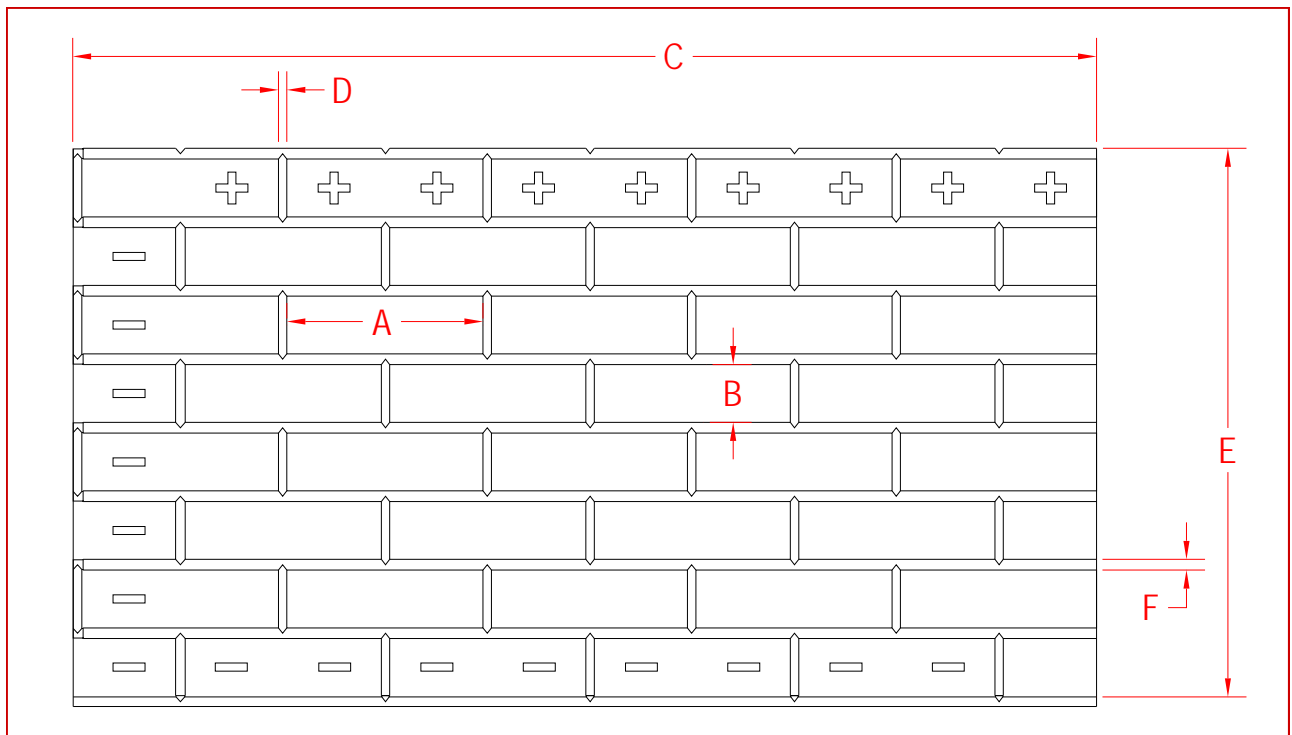

**Coverage / Piece**

Square Feet.... 7.56  
Linear Feet..... 3.32

**Shipping Info**

Box size .. 7"x28"x40"  
Pcs per box .... 50  
Box weight ... 48 lbs  
SF per box ... 378

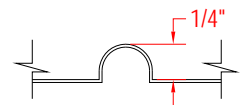

**COVE JOINT**

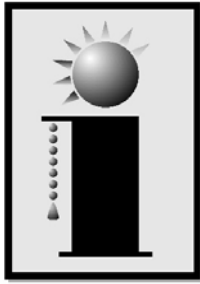

**INNOVATIVE**  
BRICK SYSTEMS, L.L.C.

**Innovative Brick Systems, L.L.C.**  
11625 Reed Ct.  
Broomfield, Co. 80020  
800-413-4588

**VersaLiner®**  
**#170 "V" Joint**  
**Modular Flemish Bond**

**Dimensions**

A... 7 5/8"  
B... 2 1/4"  
C...\* 32 3/8"  
D... 3/8"  
E...\* 27.083"  
F... .4166"

\* ±1/8" for normal thermal expansion and contraction

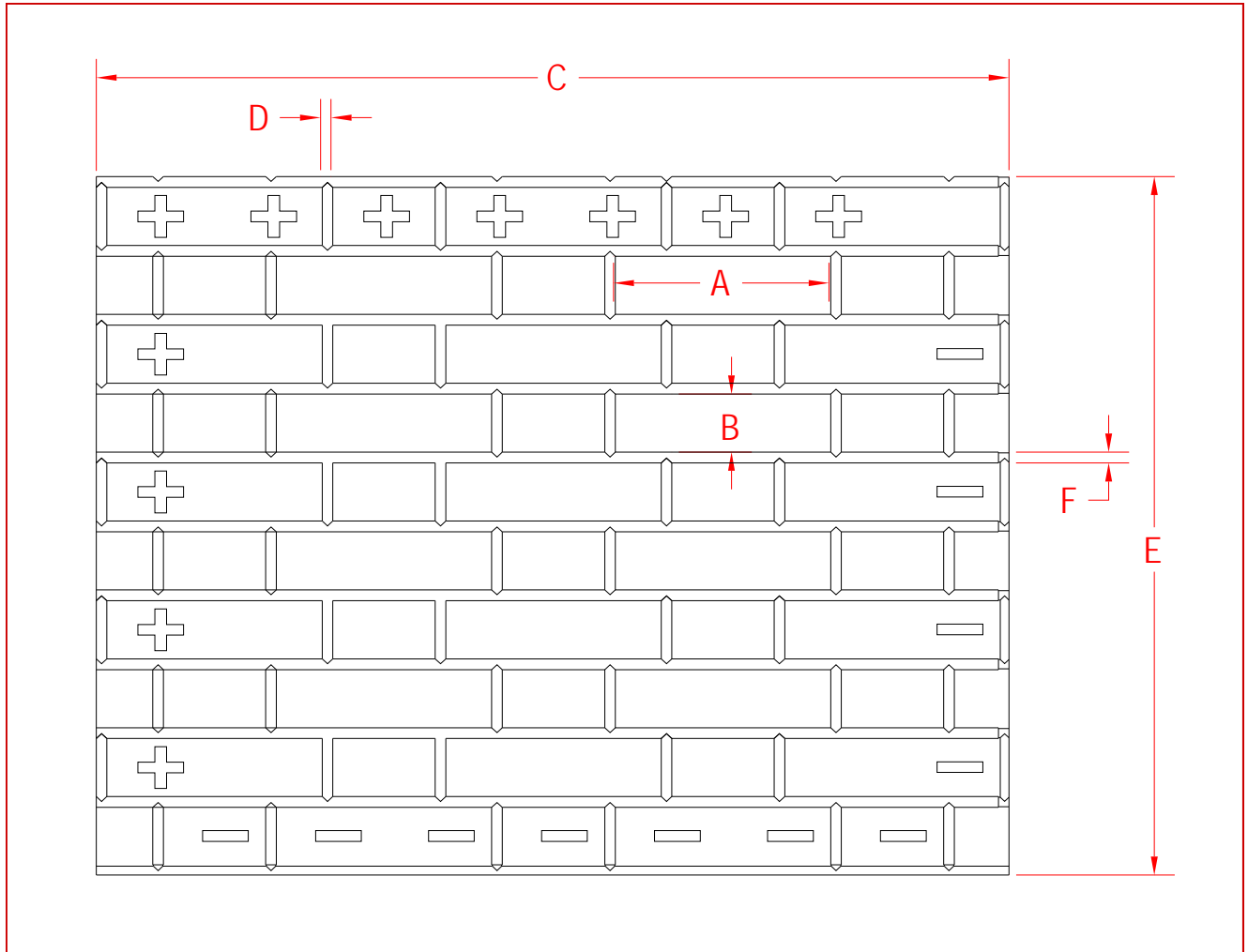

**Coverage / Piece**

Square Feet.... 5.92  
Linear Feet..... 2.66

**Shipping Info**

Box size .. 7"x28"x33"  
Pcs per box ..... 50  
Box weight ... 37 lbs  
SF per box .....296

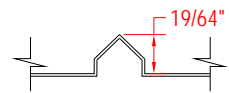

**V JOINT**

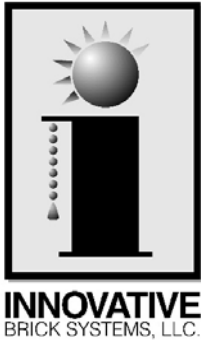

Innovative Brick Systems, L.L.C.  
11625 Reed Ct.  
Broomfield, Co. 80020  
800-413-4588

**Dimensions**  
 A... 7 5/8"  
 B... 2 1/4"  
 C...\* 48"  
 D... 3/8"  
 E...\* 21 3/8"N  
 F... .417"  
 \* ±1/8" for normal thermal expansion and contraction

**VersaLiner®**  
**#180 Modular Running Bond**  
**1/8" Deep Rake Joint**

Patent Number: D,479,614

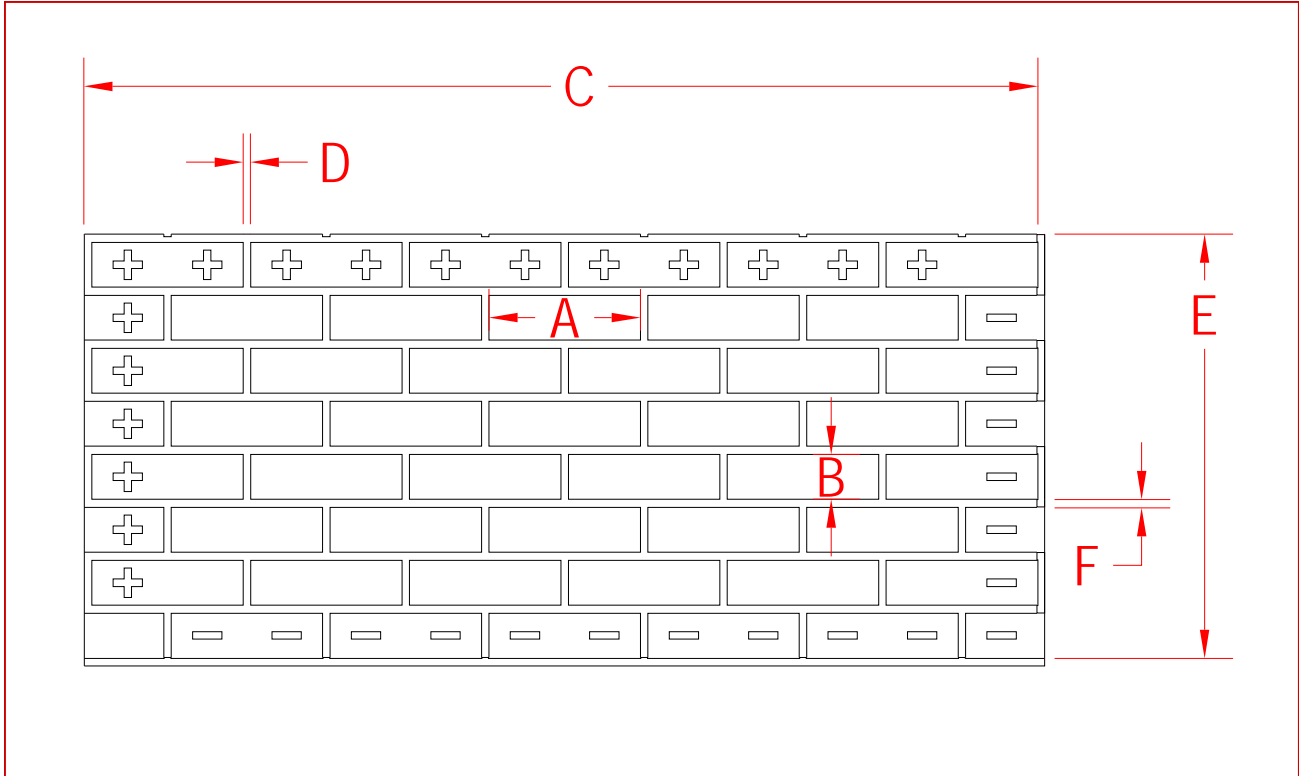

<b><u>Coverage / Piece</u></b>	
Square Feet....	7.11
Linear Feet.....	4

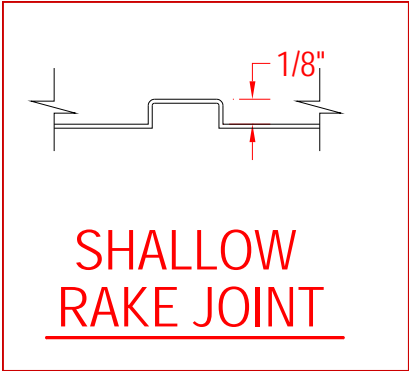

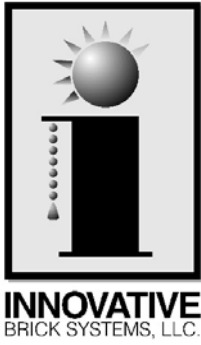

Innovative Brick Systems, L.L.C.  
 11625 Reed Ct.  
 Broomfield, Co. 80020  
 800-413-4588

***Dimensions***  
 A... 2 1/4"N  
 B... 7 5/8"N  
 C...\* 48"  
 D... .417"N  
 E...\* 8"  
 F... 3/8"N

\* ±1/8" for normal thermal expansion and contraction

**VersaLiner®  
 #126  
 Rough Brick Soldier**

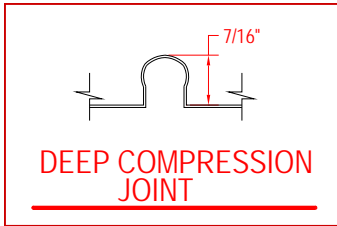
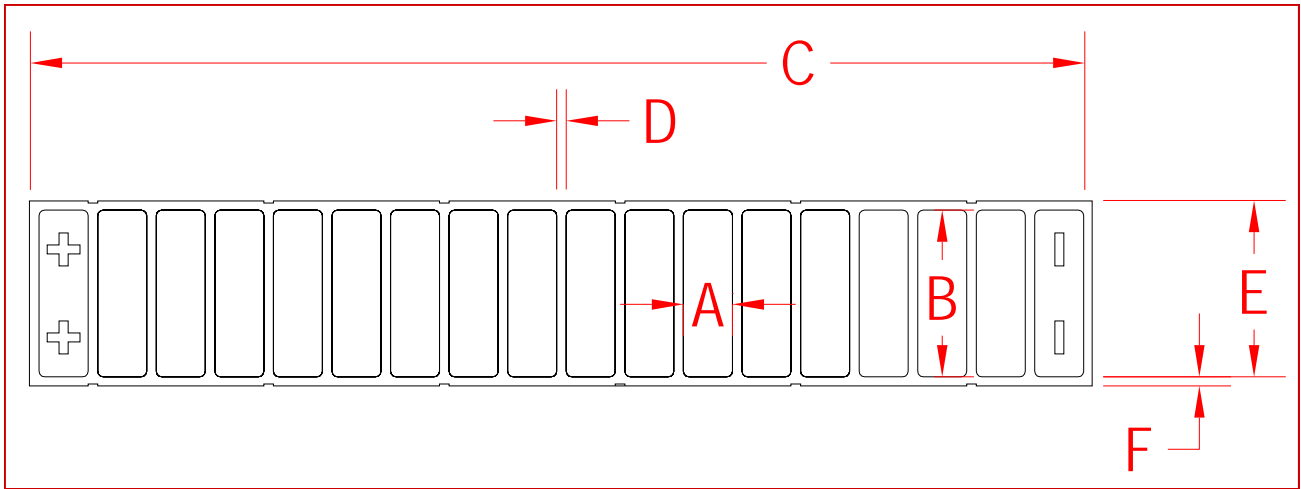

Compression Joint On  
 Head Joint Only

<b><i>Coverage / Piece</i></b>	
Square Feet....	2.67
Linear Feet....	4



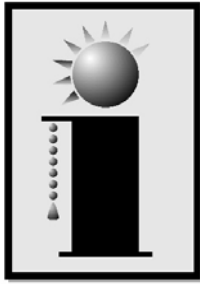

**INNOVATIVE**  
BRICK SYSTEMS, L.L.C.

**Innovative Brick Systems, L.L.C.**  
11625 Reed Ct.  
Broomfield, Co. 80020  
800-413-4588

**VersaLiner®**  
**#3500C Modular Herringbone**

**Dimensions**

A... 7 5/8"  
B... 2 1/4"  
C...\* 25 1/16"  
D... .3958"  
E...\* 47 3/4"  
F... .3958"

\* ±1/8" for normal thermal expansion and contraction

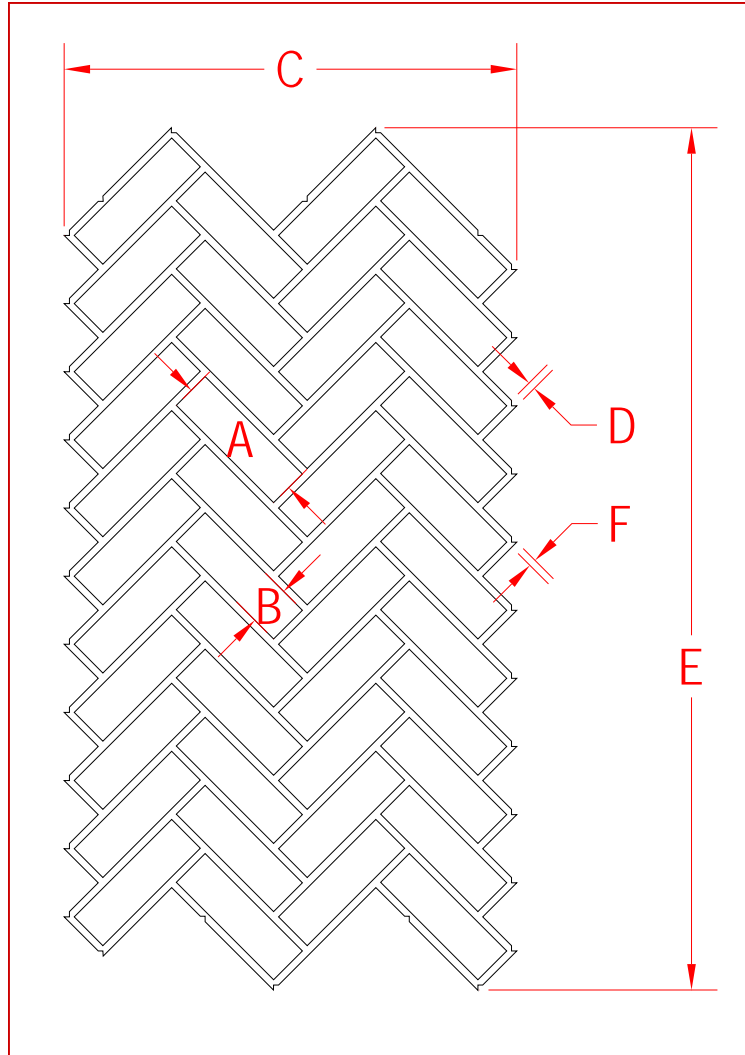

**Coverage / Piece**

Square Feet.... 6.5

**Shipping Info**

Box size ..  
Pcs per box ..... 50  
Box weight ...  
SF per box .....325

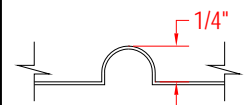

**COVE JOINT**

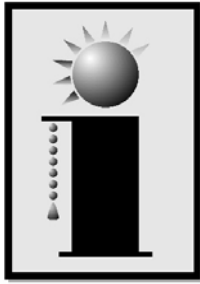

**INNOVATIVE**  
BRICK SYSTEMS, L.L.C.

**Innovative Brick Systems, L.L.C.**  
11625 Reed Ct.  
Broomfield, Co. 80020  
800-413-4588

**VersaLiner®**  
**#S-101 Modular Running Bond**  
**Compression Fit Joint**  
**Special Adj. for U of H**

**Dimensions**

A... 2 1/4"

B... 7 5/8"

C...\* 24"

D... 3/8"

E...\* 37"

**F... .391"**

\* ±1/8" for normal thermal expansion and contraction

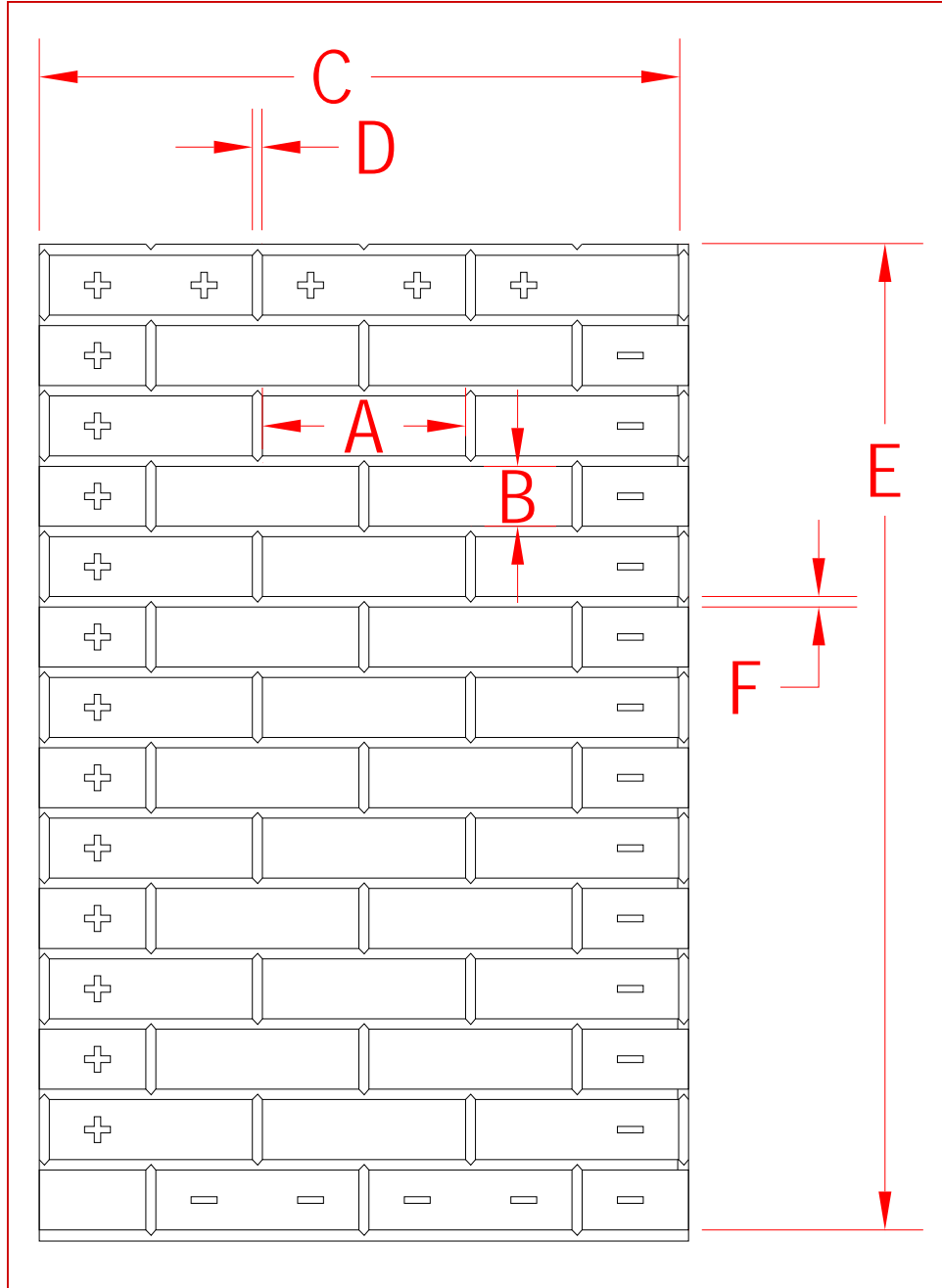

**Coverage / Piece**

Square Feet.... 6.17

Linear Feet.... 2

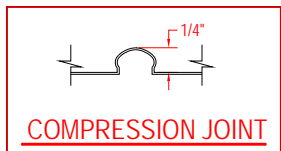

**Patent Number: D,479,614**

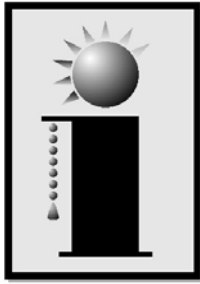

**INNOVATIVE**  
BRICK SYSTEMS, L.L.C.

**Innovative Brick Systems, L.L.C.**  
11625 Reed Ct.  
Broomfield, Co. 80020  
800-413-4588

**VersaLiner®**  
**# S-116 Drip Ledge**

**Dimensions**

A... 7 5/8"  
B... 2 1/4"  
C...\* 32 3/8"  
D... 3/8"  
E...\* 11 5/8"  
F... .4166"

\* ±1/8" for normal thermal expansion and contraction

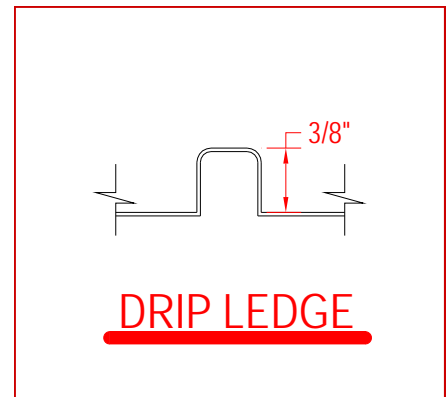
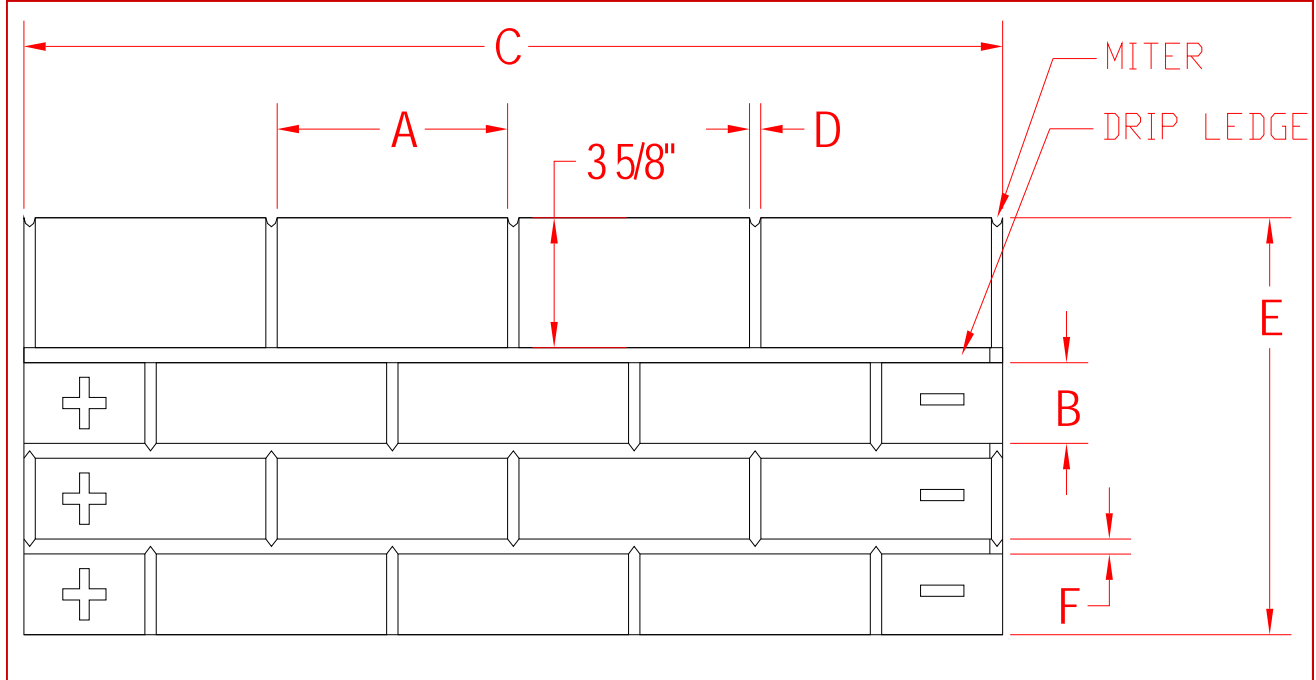

<b><u>Coverage / Piece</u></b>	
Square Feet....	2.50
Linear Feet.....	2.66

<b><u>Shipping Info</u></b>	
Box size ..	7"x28"x33"
Pcs per box	.... 100
Box weight	... 37 lbs
SF per box	.....250

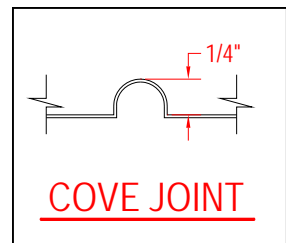

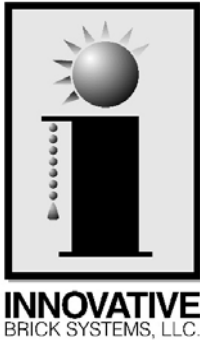

Innovative Brick Systems, L.L.C.  
 11625 Reed Ct.  
 Broomfield, Co. 80020  
 800-413-4588

**Dimensions**

A	7-5/8"
B	2-1/4"
C	32.216"
D	.429"
E	43-1/16"
F	.4167"

\* ±1/8" for normal thermal expansion and contraction

**VersaLiner®**  
**#S122L Modular Running Bond**  
**Expanded Joint for 5'4" Width**

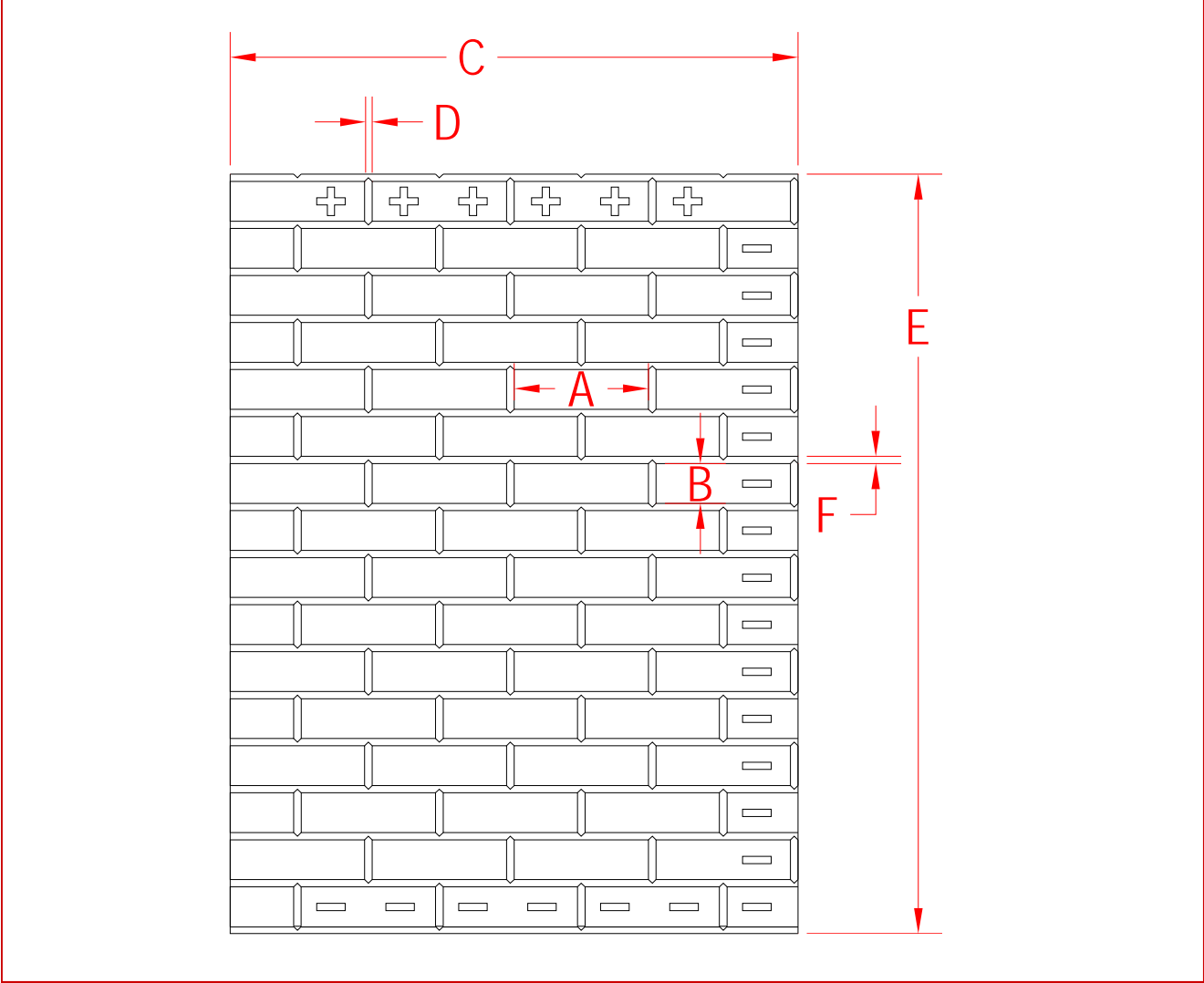

**Coverage /2 Pieces**

Square Feet.... 19  
 Linear Feet..... NA

Patent Number: D,479,614

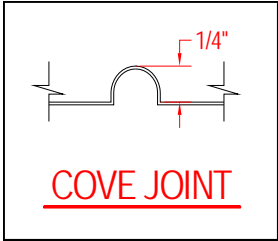

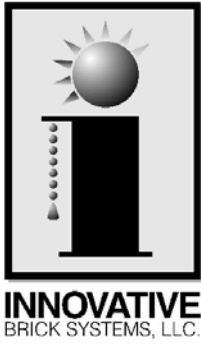

Innovative Brick Systems, L.L.C.  
11625 Reed Ct.  
Broomfield, Co. 80020  
800-413-4588

**Dimensions**

A	7-5/8"
B	2-1/4"
C	32.216"
D	.429"
E	43-1/16"
F	.4167"

\* ±1/8" for normal thermal expansion and contraction

**VersaLiner®**  
**#S122R Modular Running Bond**  
**Expanded Joint for 5'4" Width**

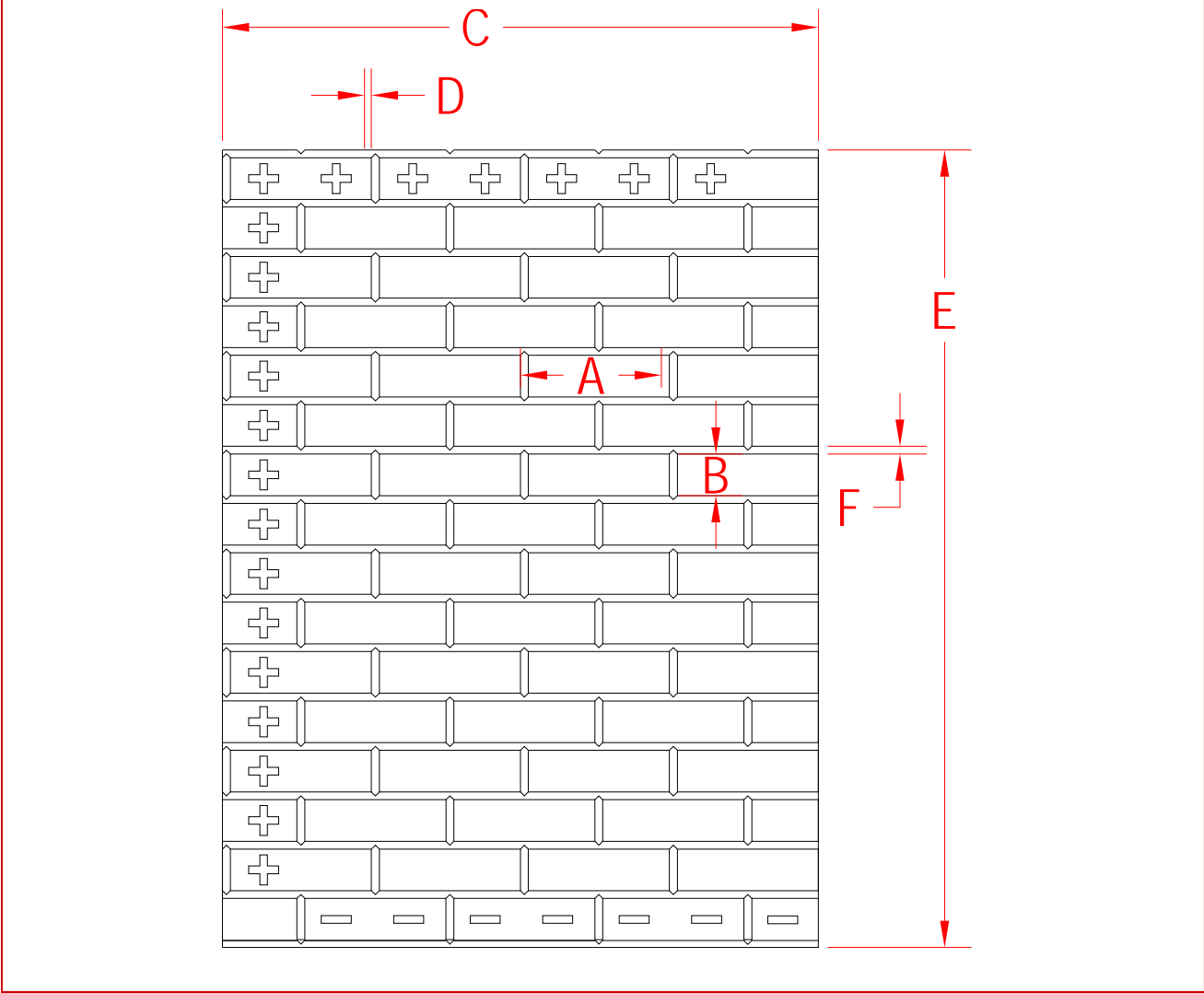

**Coverage / 2 Pieces**

Square Feet.... 19  
Linear Feet..... NA

Patent Number: D,479,614

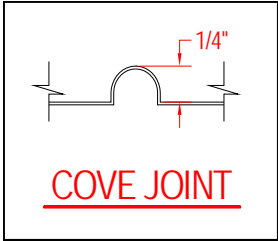

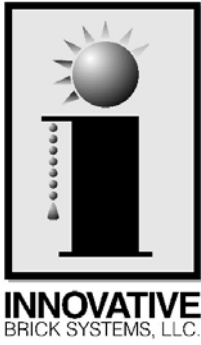

Innovative Brick Systems, L.L.C.  
 11625 Reed Ct.  
 Broomfield, Co. 80020  
 800-413-4588

**Dimensions**  
 A... 7 5/8"  
 B... 2 1/4"  
 C...\* 52"  
 D... .4063"  
 E...\* 43 1/16"  
 F... .4166"  
 \* ±1/8" for normal thermal expansion and contraction

**VersaLiner®**  
**#S123 Modular Running Bond**  
**Expanded Joint for 4'4" Width**

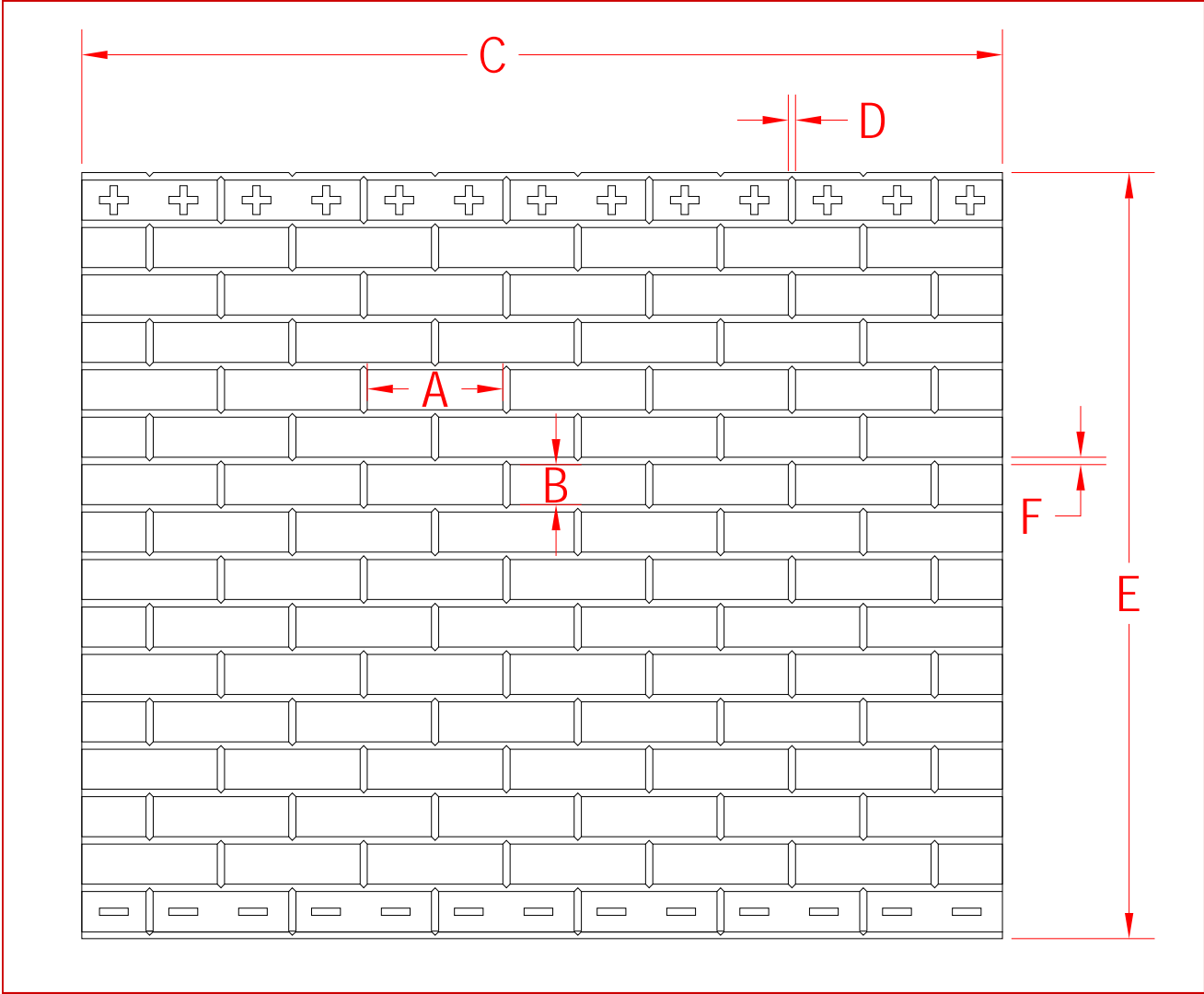

**Coverage / Piece**

Square Feet.... 15.6  
 Linear Feet..... NA

Patent Number: D,479,614

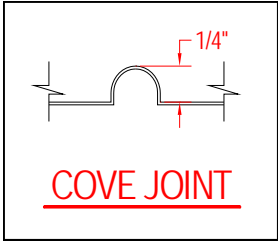

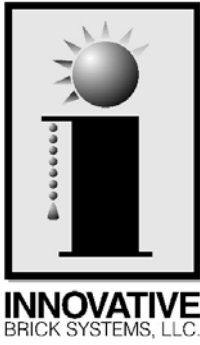

Innovative Brick Systems, L.L.C.  
11625 Reed Ct.  
Broomfield, Co. 80020  
800-413-4588

**Dimensions**  
 A... 7 5/8"  
 B... 2 1/4"  
 C...\* 24 1/4"  
 D... .3482"  
 E...\* 43 1/16"  
 F... .4167"  
 \* ±1/8" for normal thermal expansion and contraction

**VersaLiner®**  
**#S128 Modular Running Bond**  
**Compressed Head Joints**

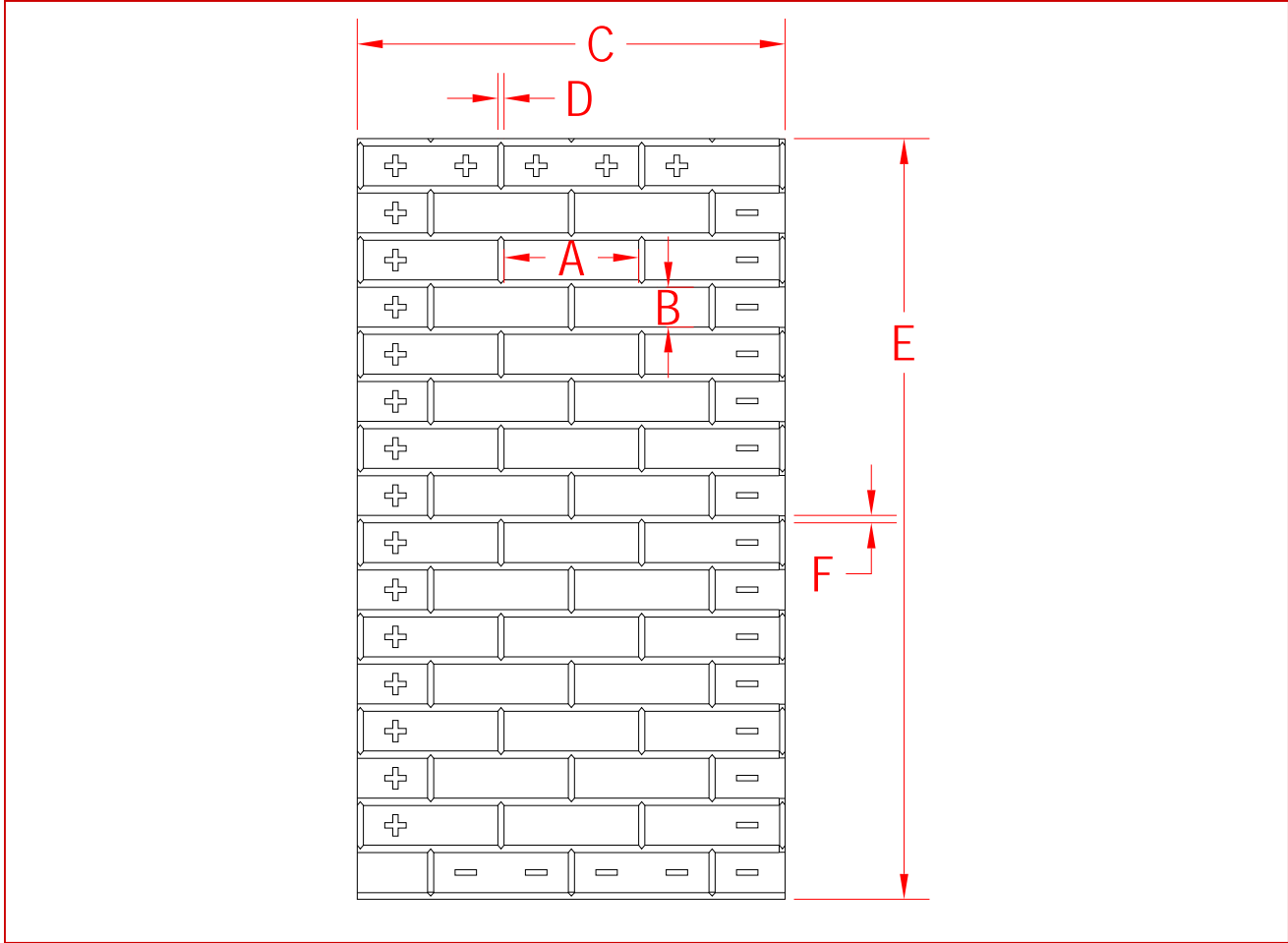

15 bricks & 14 joints = 9' 11-1/4" wide

**Coverage / Piece**

Square Feet.... 7.16  
 Linear Feet..... 2

Patent Number: D,479,614

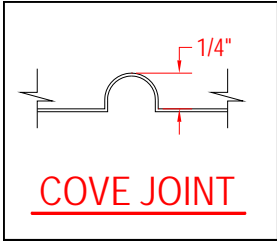

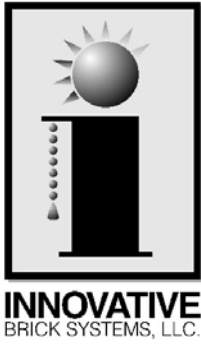

Innovative Brick Systems, L.L.C.  
 11625 Reed Ct.  
 Broomfield, Co. 80020  
 800-413-4588

**Dimensions**  
 A... 2 1/4"  
 B... 7 5/8"  
 C...\* 24 5/16"  
 D... .4077  
 E...\* 8" Nom  
 F... .3958

\* ±1/8" for normal thermal expansion and contraction

**VersaLiner®**  
**#S129 Modular Soldier**  
**Compressed Bed Joints**

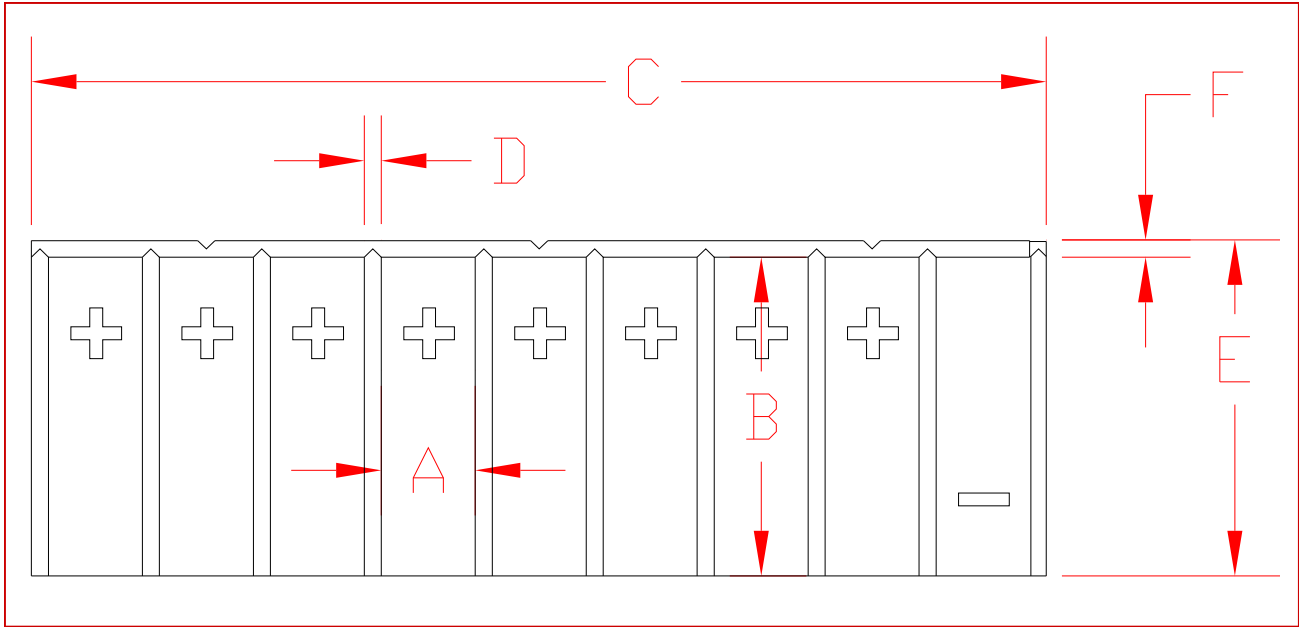

27 Bricks and 26 joints = 5' 11 3/8"

**Coverage / Piece**

Square Feet.... 1.33  
 Linear Feet..... 2

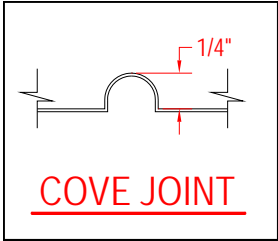

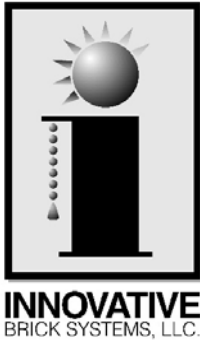

Innovative Brick Systems, L.L.C.  
11625 Reed Ct.  
Broomfield, Co. 80020  
800-413-4588

**Dimensions**  
A... 7 5/8"  
B... 2 1/4"  
C...\* 24 3/8"  
D... 3/8"  
E...\* 32 7/16th"  
F... .4166"  
\* ±1/8" for normal thermal expansion and contraction

**VersaLiner®**  
**#S - 143 Modular Running Bond**  
**Flemish course every 6 th row**

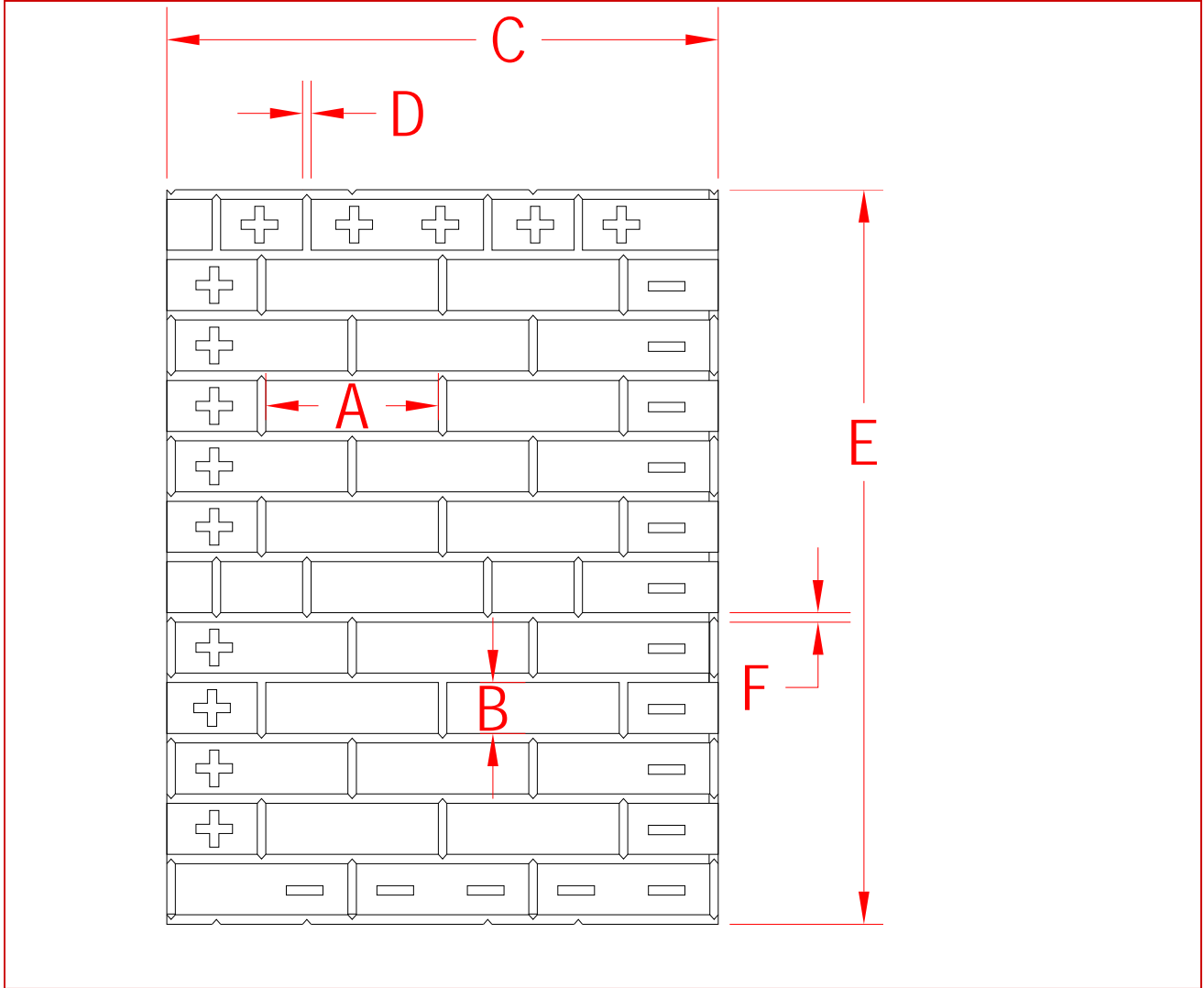

**Coverage / Piece**  
Square Feet.... 5.4  
Linear Feet..... 2.05

**Shipping Info**  
Box size .. 7"x28"x33"  
Pcs per box ..... 50  
Box weight ... 37 lbs  
SF per box .....270

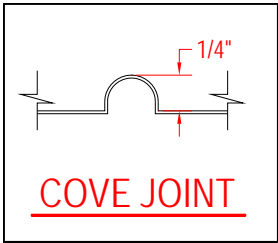

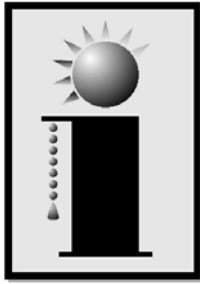

**INNOVATIVE**  
BRICK SYSTEMS, L.L.C.

**Innovative Brick Systems, L.L.C.**  
11625 Reed Ct.  
Broomfield, Co. 80020  
800-413-4588

**VersaLiner®**  
**#200 Closure Running Bond**

**Dimensions**

- A... 7 5/8"
- B... 3 5/8"
- C...\* 32 3/8"
- D... 3/8"
- E...\* 24 3/8"
- F... 3/8"

\* ±1/8" for normal thermal expansion and contraction

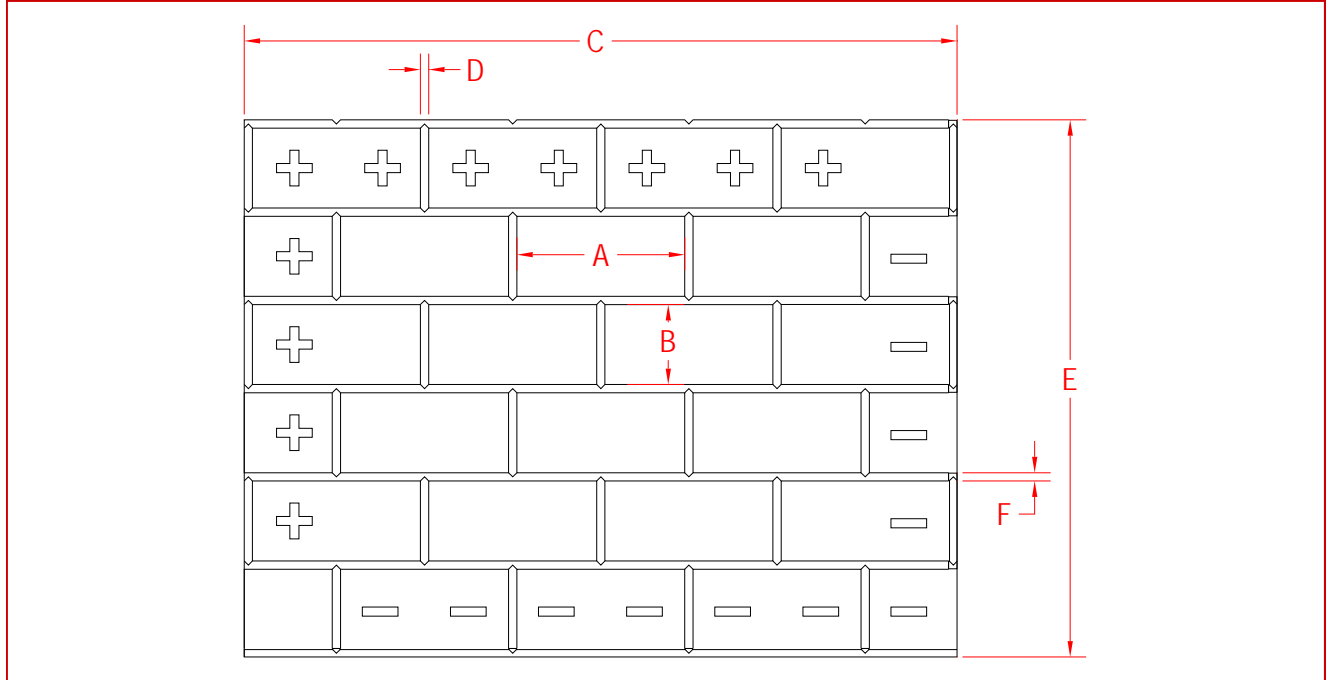

**Finished Pattern**

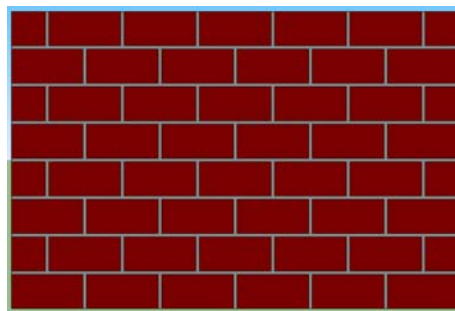

**Coverage / Piece**

Square Feet.... 5.33  
Linear Feet..... 2.66

**Shipping Info**

Box size .. 7"x28"x33"  
Pcs per box .... 50  
Box weight ... 37 lbs  
SF per box .....267

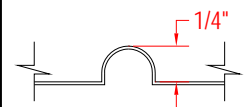

**COVE JOINT**

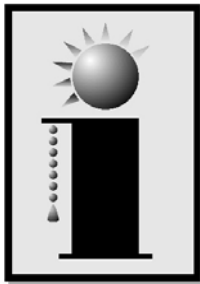

**INNOVATIVE**  
BRICK SYSTEMS, L.L.C.

**Innovative Brick Systems, L.L.C.**  
11625 Reed Ct.  
Broomfield, Co. 80020  
800-413-4588

**VersaLiner®**  
**#215 Closure Folding Corner**

**Dimensions**

A... 7 5/8"  
B... 3 5/8"  
C...\* 16 3/8"  
D... 3/8"  
E...\* 24 3/8"  
F... ,417"

\* ±1/8" for normal thermal expansion and contraction

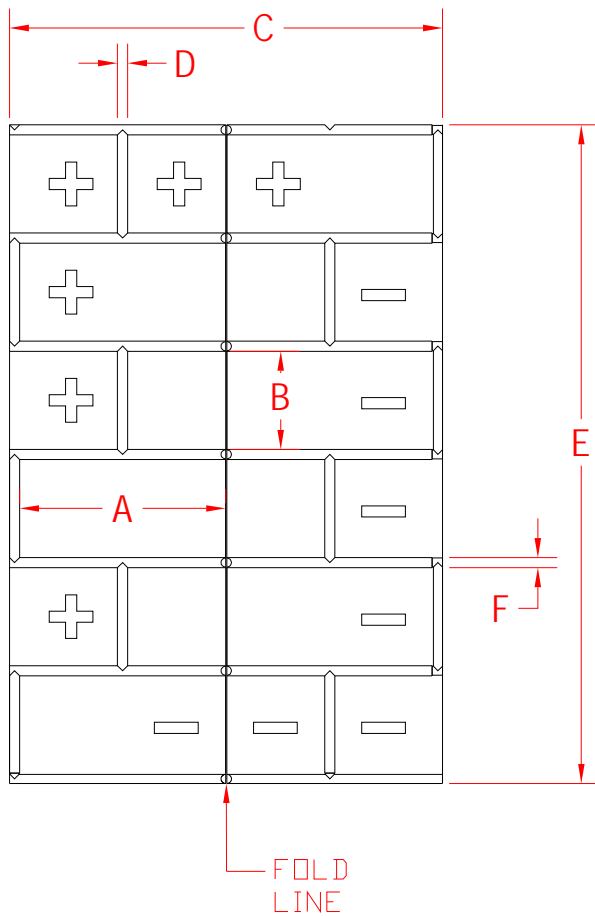

**Finished Pattern**

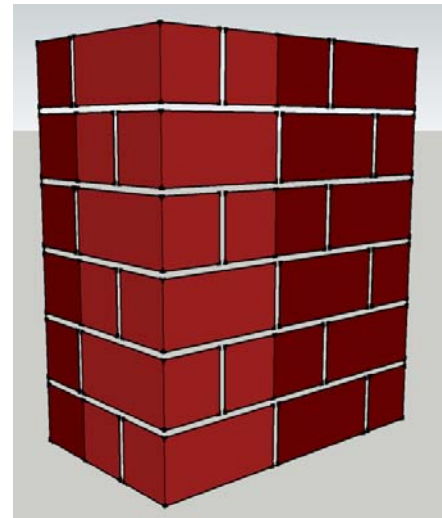

**Coverage / Piece**

Square Feet.... 2.66  
Linear Feet..... 2

**Shipping Info**

Box size .. 7"x28"x33"  
Pcs per box ..... 100  
Box weight ... 37 lbs  
LF per box .....200

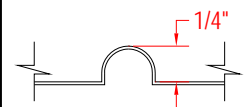

**COVE JOINT**

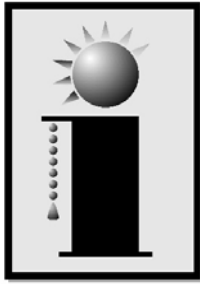

**INNOVATIVE**  
BRICK SYSTEMS, L.L.C.

Innovative Brick Systems, L.L.C.  
11625 Reed Ct.  
Broomfield, Co. 80020  
800-413-4588

**VersaLiner®**  
**#226 Closure**  
**Soldier / Stack (no saddles)**

**Dimensions**

- A... 7 5/8"
- B... 3 5/8"
- C...\* 8 3/8"
- D... 3/8"
- E...\* 48"
- F... 3/8"

\* ±1/8" for normal thermal expansion and contraction

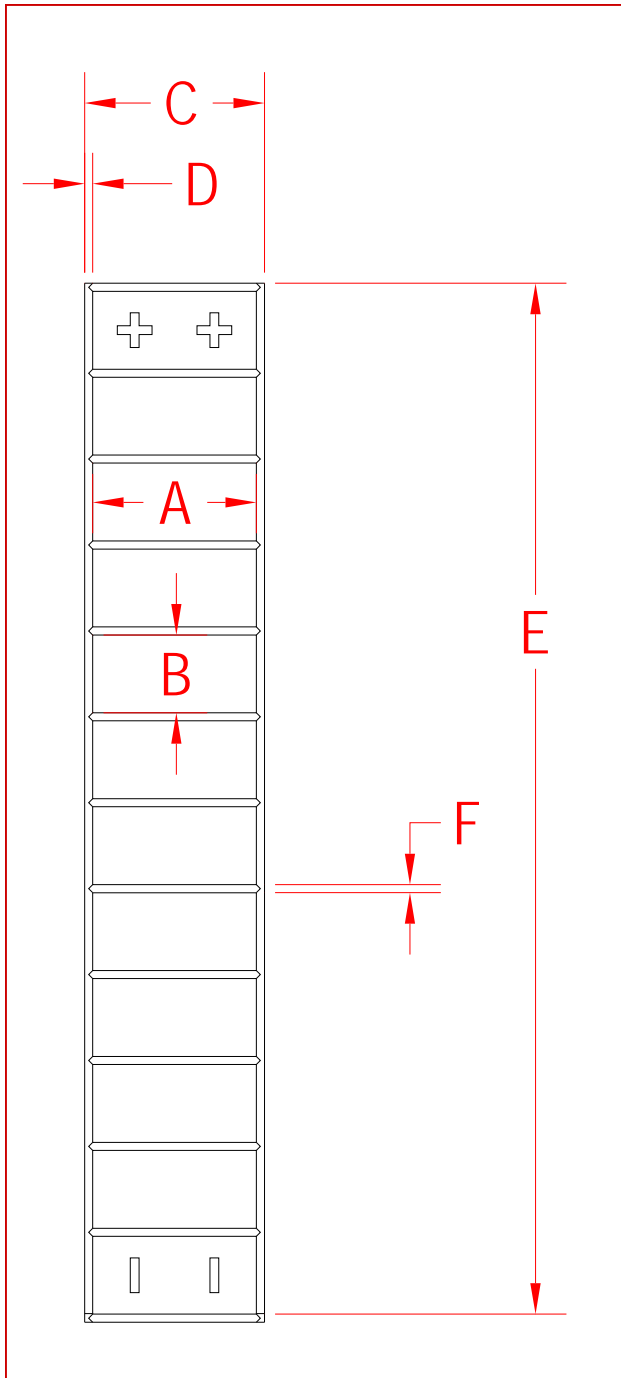

**Coverage / Piece**

Square Feet.... 2.66  
Linear Feet.... 4

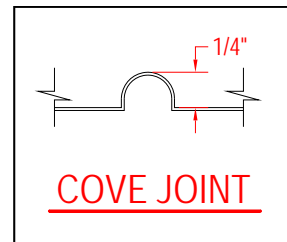

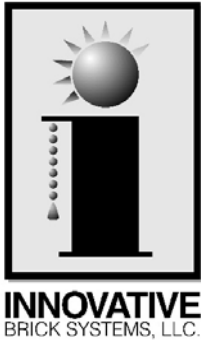

Innovative Brick Systems, L.L.C.  
11625 Reed Ct.  
Broomfield, Co. 80020  
800-413-4588

**Dimensions**  
 A... 7 5/8"  
 B... 3 5/8"  
 C...\* 40"  
 D... 3/8"  
 E...\* 24"  
 F... 3/8"  
 \* ±1/8" for normal thermal expansion and contraction

**VersaLiner®**  
**#200.1 Closure Running Bond**  
**Compression Fit Joint**

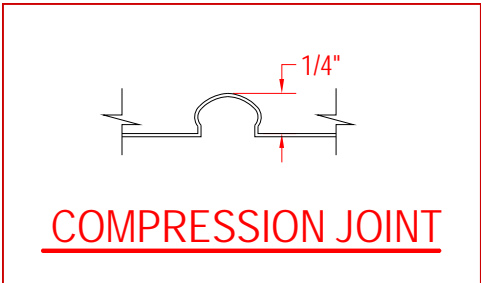
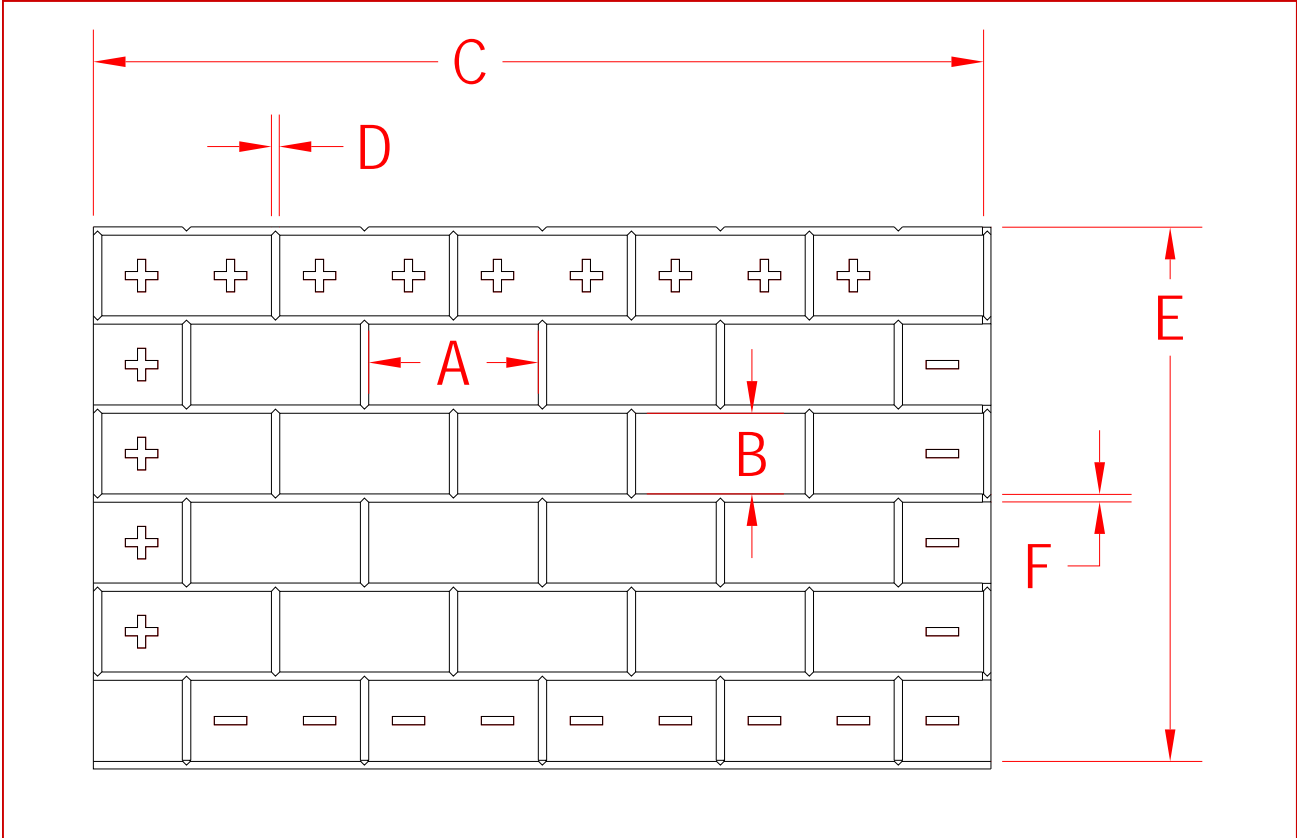

**Coverage per piece**  
 Square Ft... 8  
 Linear Ft... 4



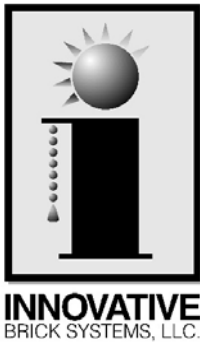

Innovative Brick Systems, L.L.C.  
11625 Reed Ct.  
Broomfield, Co. 80020  
800-413-4588

**Dimensions**  
 A... 7 5/8"  
 B... 3 5/8"  
 C...\* 8 3/8"  
 D... 3/8"  
 E...\* 48"  
 F... 3/8"  
 \* ±1/8" for normal thermal expansion and contraction

**VersaLiner®**  
**#225.1 Closure Soldier**  
**Compression Fit Joint**

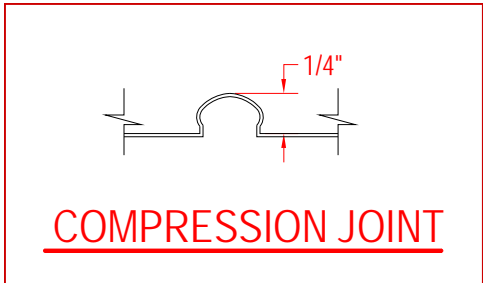
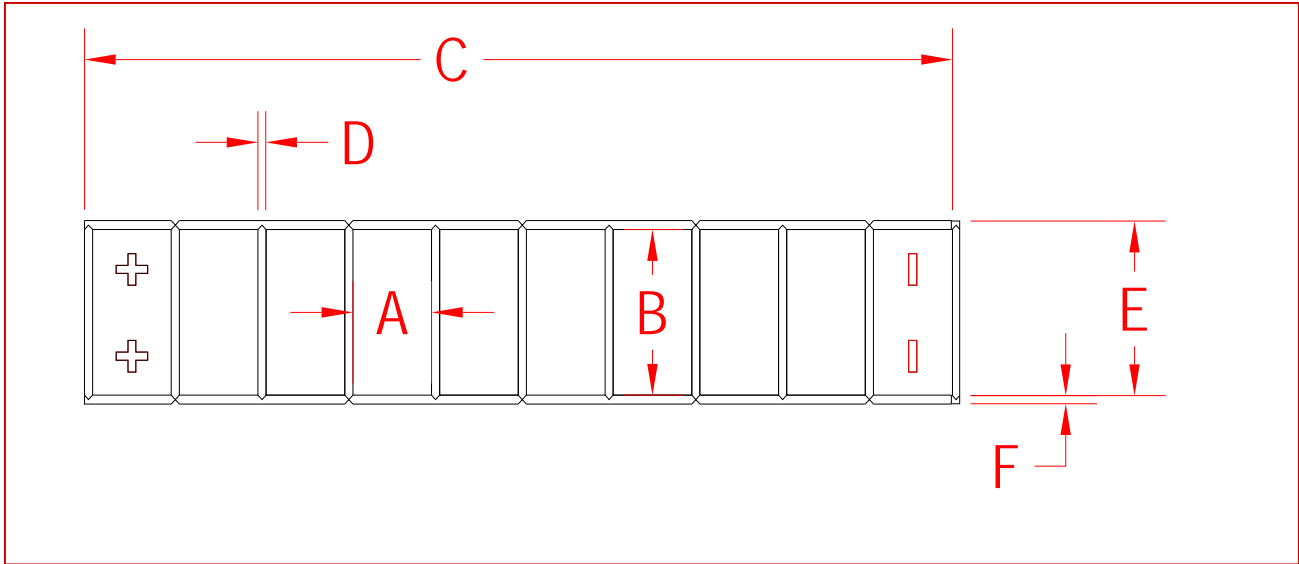

**Coverage per piece**  
 Square Ft.... 2.67  
 Linear Ft.... 4



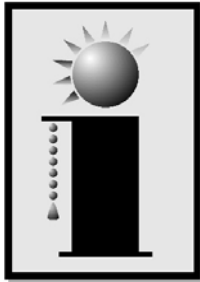

**INNOVATIVE**  
BRICK SYSTEMS, L.L.C.

Innovative Brick Systems, L.L.C.  
11625 Reed Ct.  
Broomfield, Co. 80020  
800-413-4588

**VersaLiner®**  
**#300 Norman 1/3 Bond**

**Dimensions**

A... 11 5/8"  
B... 2 1/4"  
C...\* 36 3/8"  
D... 3/8"  
E...\* 27"  
F... .4166"

\* ±1/8" for normal thermal expansion and contraction

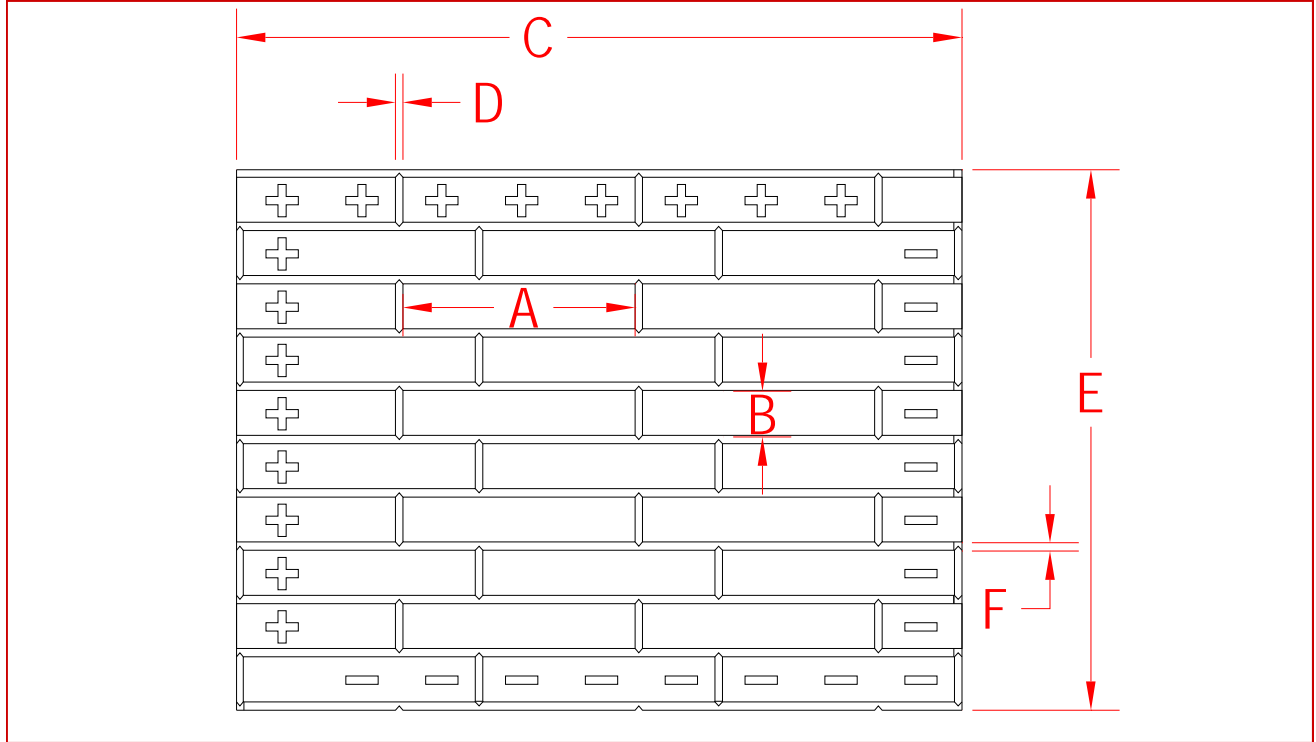

**Finished Look**



**Coverage / Piece**

Square Feet.... 6.7  
Linear Feet..... 3

**Shipping Info**

Box size .. 7"x28"x37"  
Pcs per box .... 50  
Box weight ... 40 lbs  
SF per box .....335

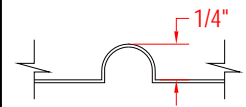

**COVE JOINT**

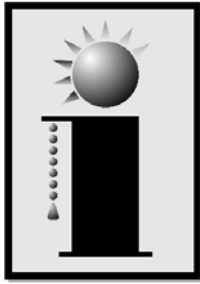

**INNOVATIVE**  
BRICK SYSTEMS, L.L.C.

**Innovative Brick Systems, L.L.C.**  
11625 Reed Ct.  
Broomfield, Co. 80020  
800-413-4588

**VersaLiner®**  
**#320 Norman Stacked Bond**  
**3 Wide**

**Dimensions**

A... 11 5/8"  
B... 2 1/4"  
C...\* 36 3/8"  
D... 3/8"  
E...\* 32 9/16"  
F... .4166"

\* ±1/8" for normal thermal expansion and contraction

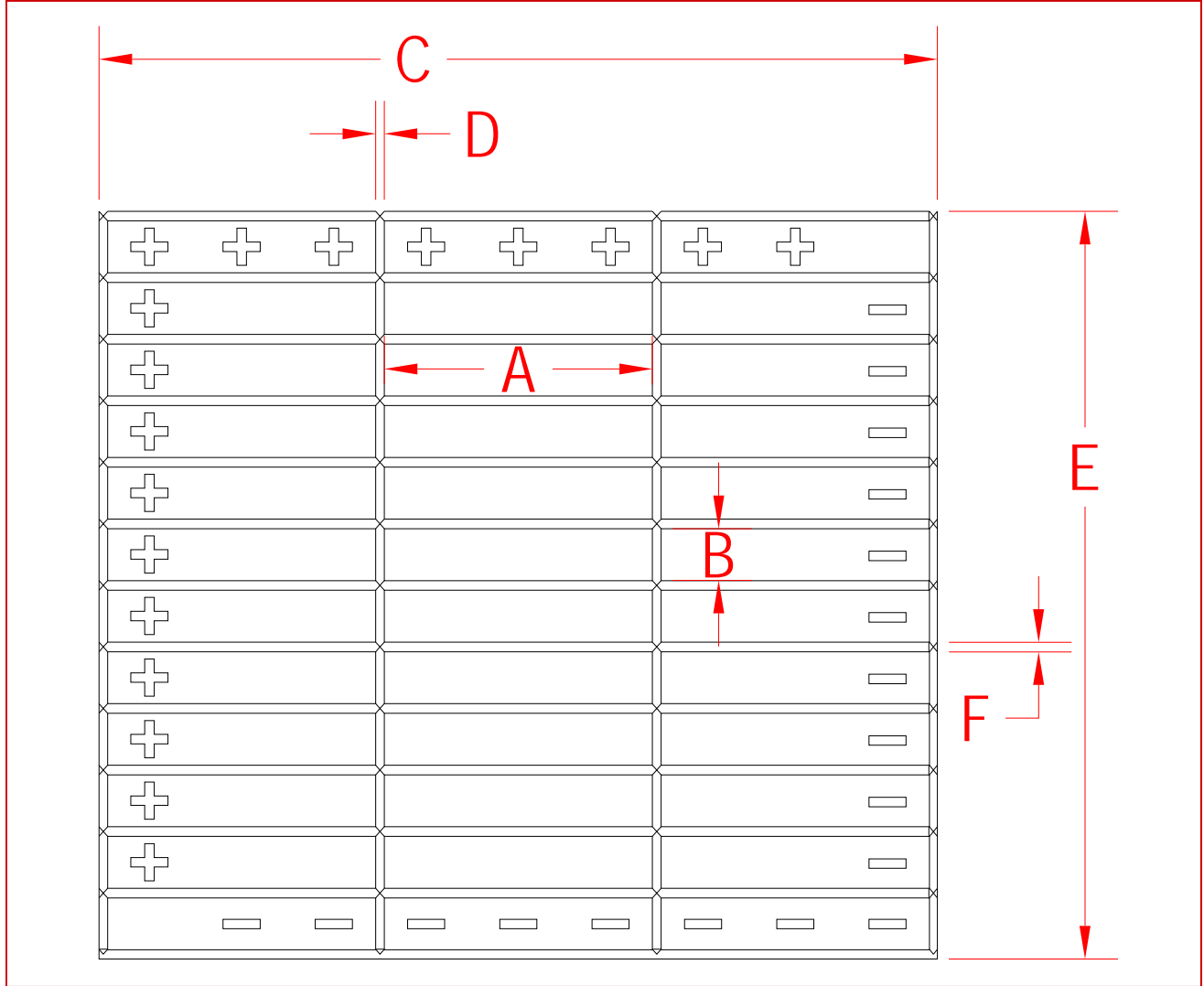

**Coverage / Piece**

Square Feet... 8  
Linear Feet.... 3

**Shipping Info**

Box size ..  
Pcs per box .....  
Box weight ...  
SF per box .....

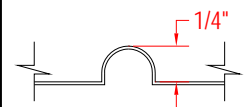

**COVE JOINT**

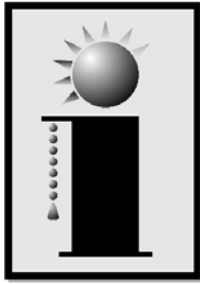

**INNOVATIVE**  
BRICK SYSTEMS, L.L.C.

**Innovative Brick Systems, L.L.C.**  
11625 Reed Ct.  
Broomfield, Co. 80020  
800-413-4588

**VersaLiner®**  
**#321 Norman Stacked Bond**  
**4 Wide**

**Dimensions**

A... 11 5/8"  
B... 2.23"  
C...\* 48 1/4"  
D... 3/8"  
E...\* 43"  
F... .4166"

\* ±1/8" for normal thermal expansion and contraction

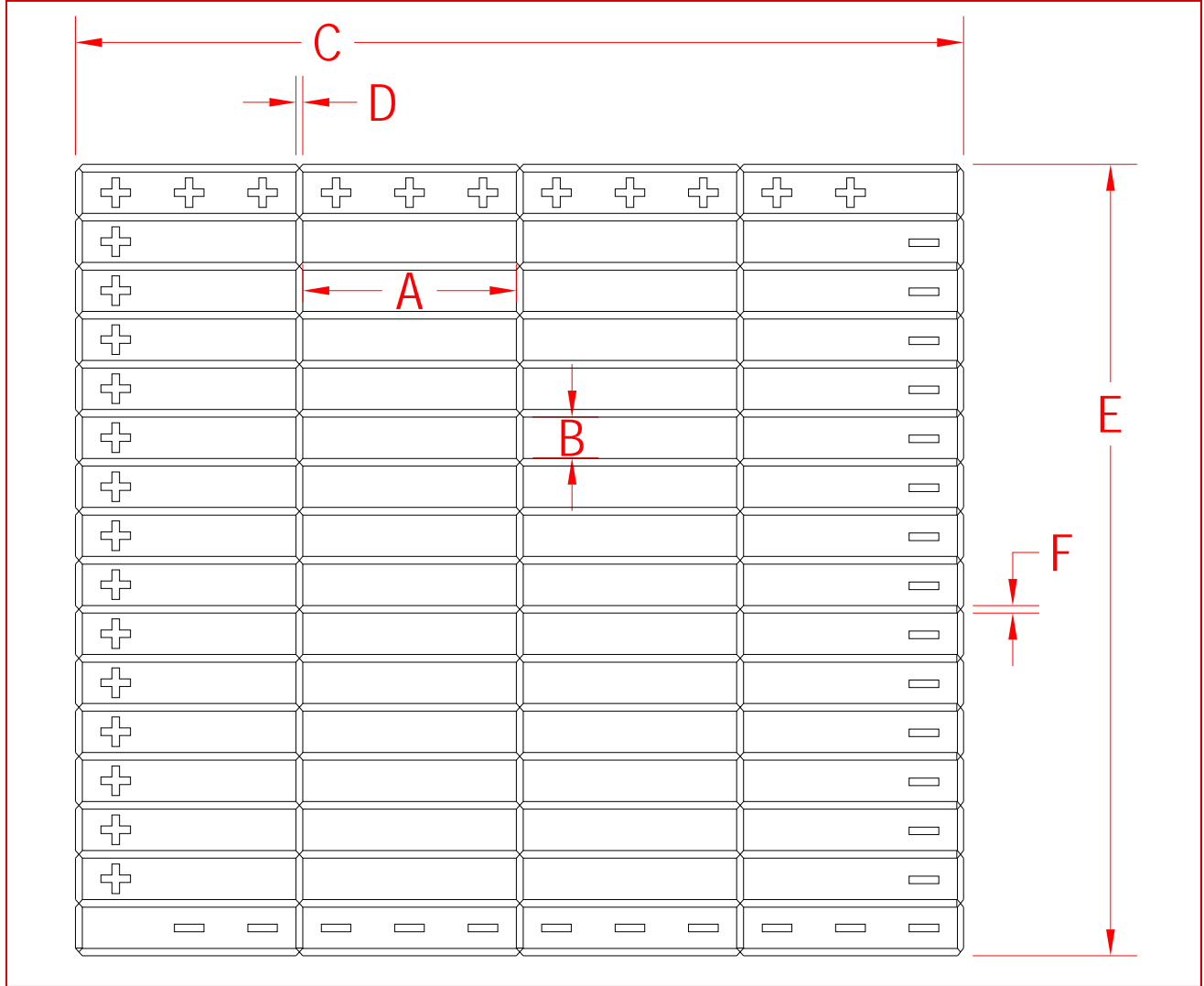

**Coverage / Piece**

Square Feet.... 14.3  
Linear Feet..... 4

**Shipping Info**

Box size ..  
Pcs per box ....  
Box weight ...  
SF per box .....

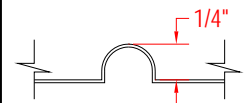

**COVE JOINT**

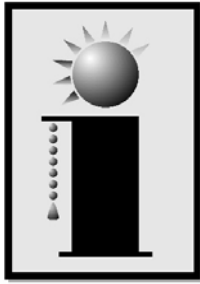

**INNOVATIVE**  
BRICK SYSTEMS, L.L.C.

**Innovative Brick Systems, L.L.C.**  
11625 Reed Ct.  
Broomfield, Co. 80020  
800-413-4588

**VersaLiner®**  
**#400 Utility Running Bond**  
**(1/2 Bond)**

**Dimensions**

A... 11 5/8"  
B... 3 5/8"  
C...\* 36 3/8"  
D... 3/8"  
E...\* 24 3/8"  
F... 3/8"

\* ±1/8" for normal thermal expansion and contraction

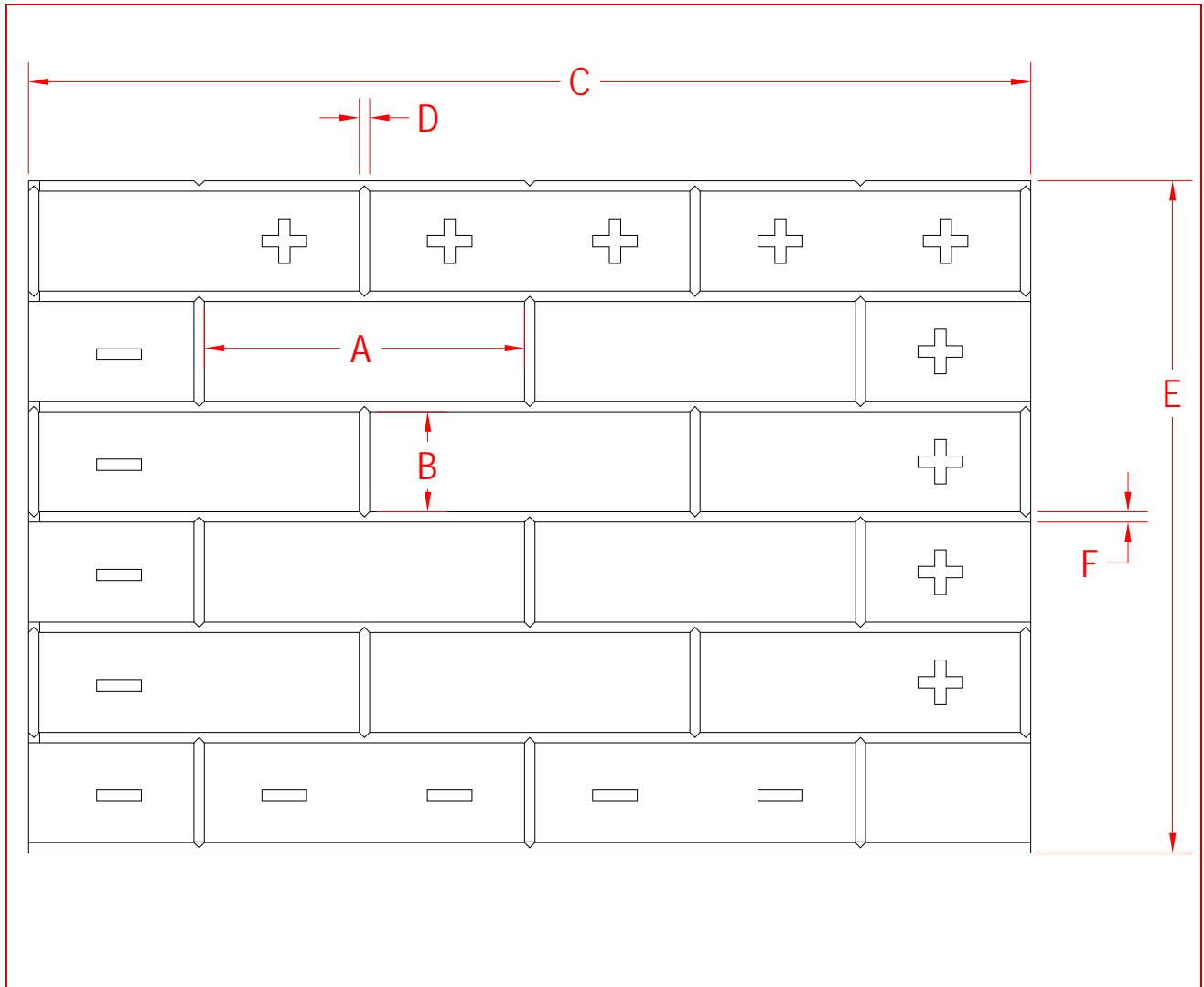

**Coverage / Piece**

Square Feet... 6

**Shipping Info**

Box size .. 7"x28"x33"  
Pcs per box .... 50  
Box weight ... 37lbs  
SF per box .....300

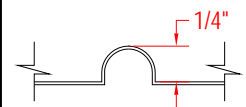

**COVE JOINT**

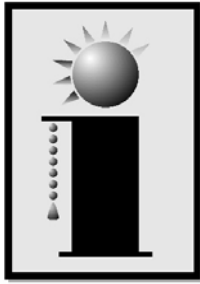

**INNOVATIVE**  
BRICK SYSTEMS, L.L.C.

**Innovative Brick Systems, L.L.C.**  
11625 Reed Ct.  
Broomfield, Co. 80020  
800-413-4588

**VersaLiner®**  
**#401**  
**Utility 1/3 Bond Rake**

**Dimensions**

A... 11 5/8"  
B... 3 5/8"  
C...\* 36 3/8"  
D... 3/8"  
E...\* 24 3/8"  
F... 3/8"

\* ±1/8" for normal thermal expansion and contraction

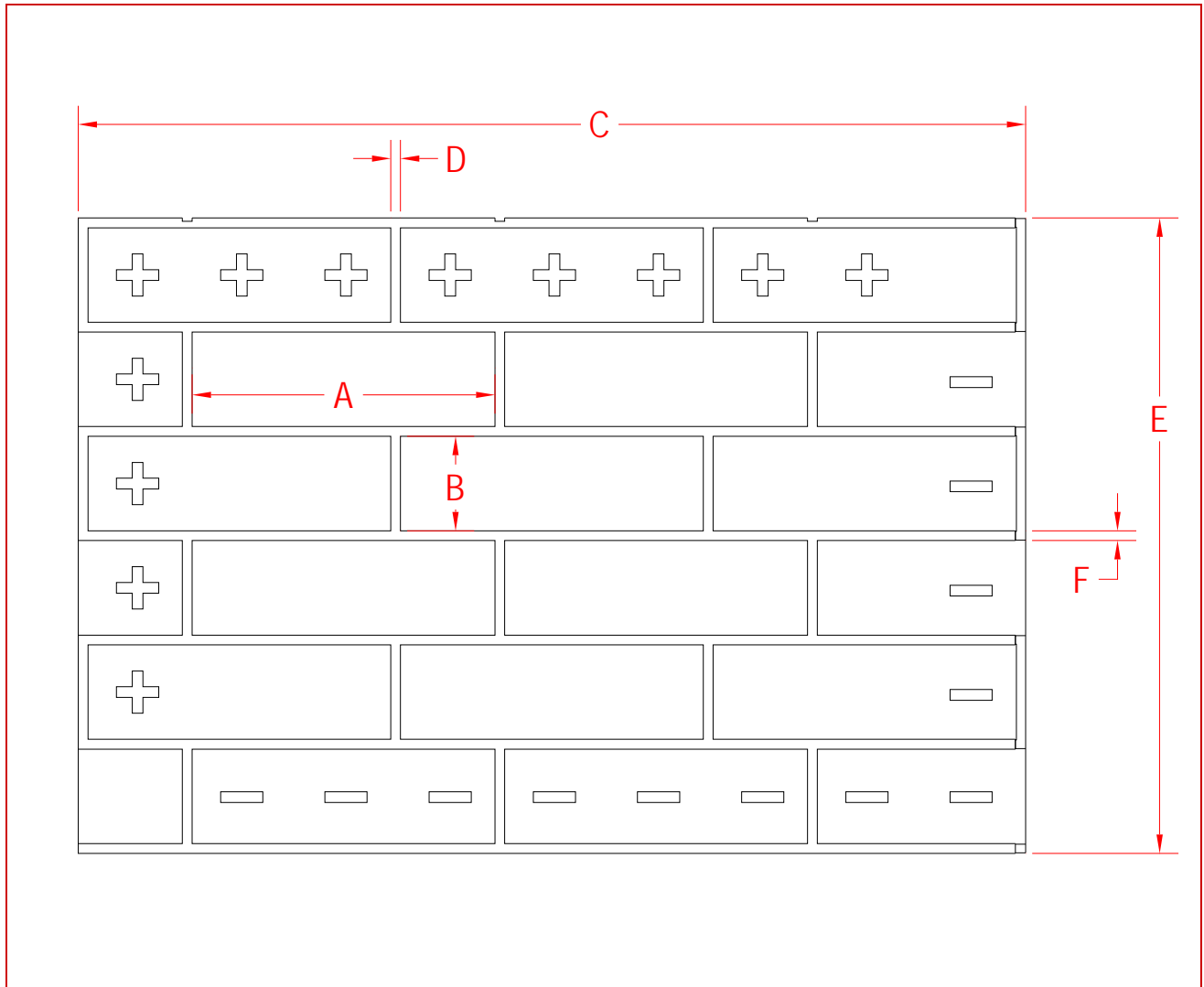

**Coverage / Piece**

Square Feet.... 6  
Linear Feet..... 3

**Shipping Info**

Box size .. 7"x28"x37"  
Pcs per box .... 30  
Box weight ... 24 lbs  
SF per box ..... 180

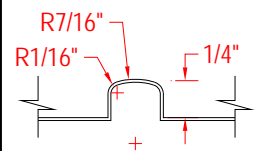

**RAKE JOINT**

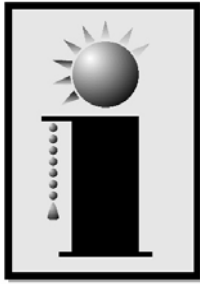

**INNOVATIVE**  
BRICK SYSTEMS, L.L.C.

**Innovative Brick Systems, L.L.C.**  
11625 Reed Ct.  
Broomfield, Co. 80020  
800-413-4588

**VersaLiner®**  
**#402**  
**Utility 1/3 Bond**

**Dimensions**

A... 11 5/8"  
B... 3 5/8"  
C...\* 36 3/8"  
D... 3/8"  
E...\* 24 3/8"  
F... 3/8"

\* ±1/8" for normal thermal expansion and contraction

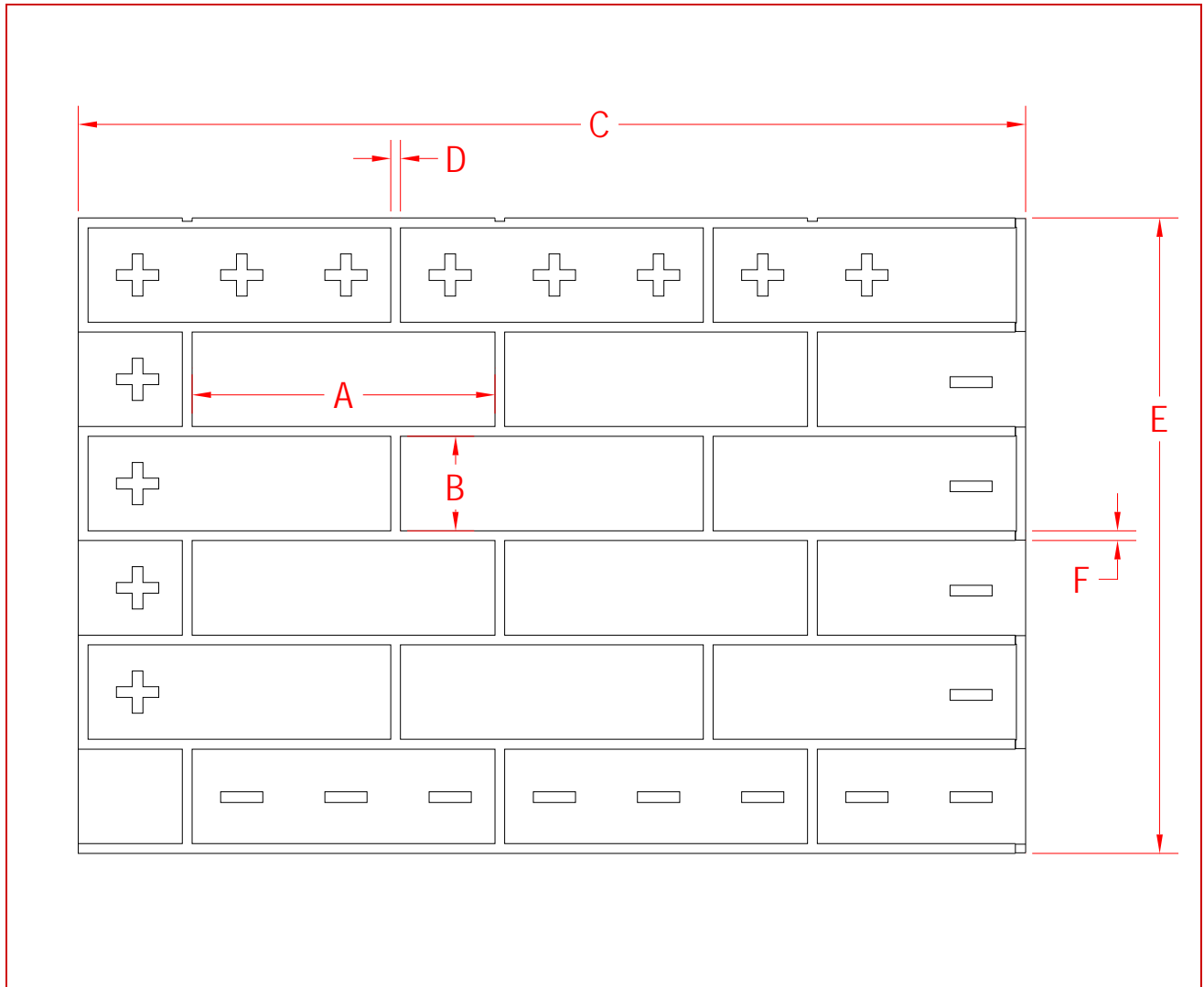

**Coverage / Piece**

Square Feet.... 6  
Linear Feet..... 3

**Shipping Info**

Box size .. 7"x28"x37"  
Pcs per box .... 30  
Box weight ... 24 lbs  
SF per box ..... 180

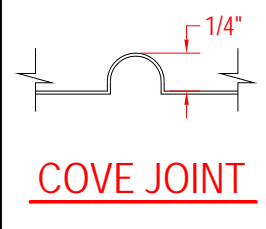

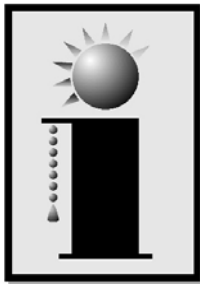

**INNOVATIVE**  
BRICK SYSTEMS, L.L.C.

**Innovative Brick Systems, L.L.C.**  
11625 Reed Ct.  
Broomfield, Co. 80020  
800-413-4588

**VersaLiner®**  
**#405 Utility Corner**  
**Transition - Left/Right**

**Dimensions**

- A... 7 5/8"
- B... 3 5/8"
- C...\* 24"
- D... 3/8"
- E...\* 40 3/8"
- F... 3/8"
- G... 9 5/8"
- H... 3 5/8"

\* ±1/8" for normal thermal expansion and contraction

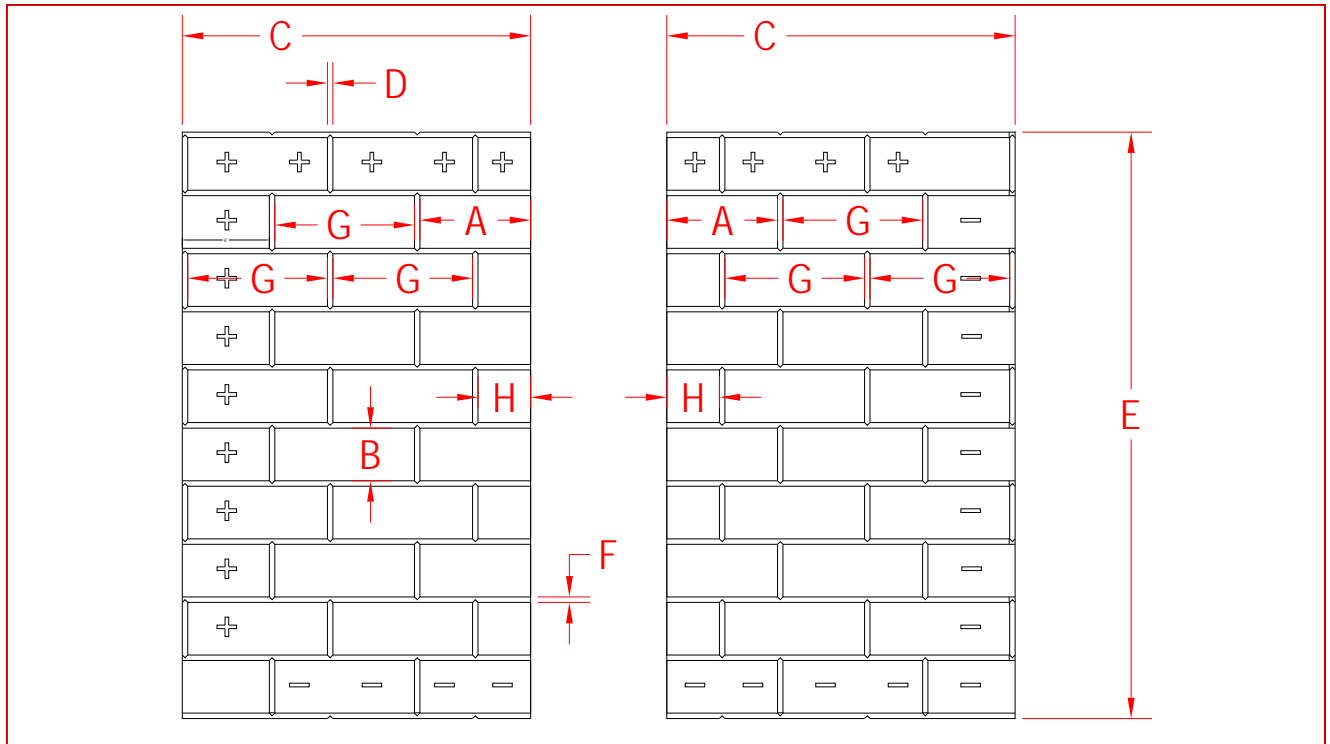

Finished Pattern L & R (lighter shade on ends)

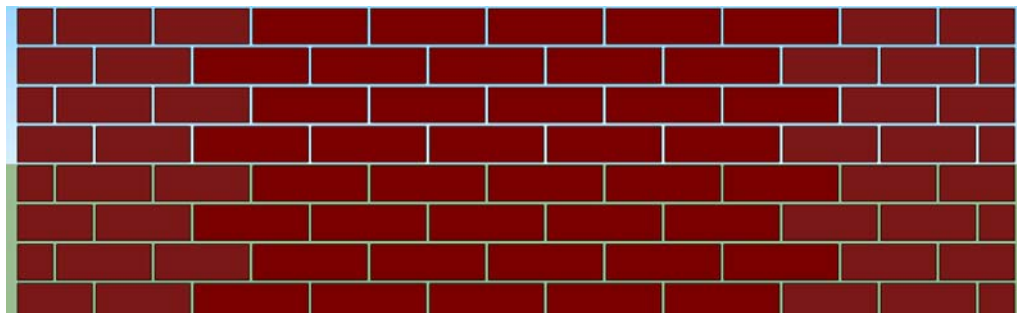

**Coverage / Piece**

Square Feet.... 6.56  
Linear Ft(vert) 3.33

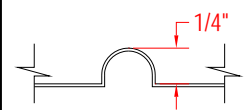

**COVE JOINT**

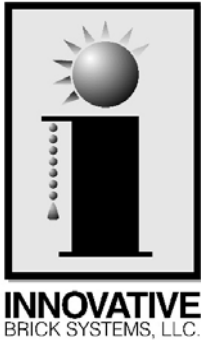

**Innovative Brick Systems, L.L.C.**  
11625 Reed Ct.  
Broomfield, Co. 80020  
800-413-4588

**Dimensions**  
A... 11 5/8"  
B... 3 5/8"  
C...\* 36 3/8"  
D... .3/8"  
E...\* 28 3/8"  
F... .4166"  
\* ±1/8" for normal thermal expansion and contraction

**VersaLiner®**  
**#420 3x**  
**Utility Stack Bond Rake**

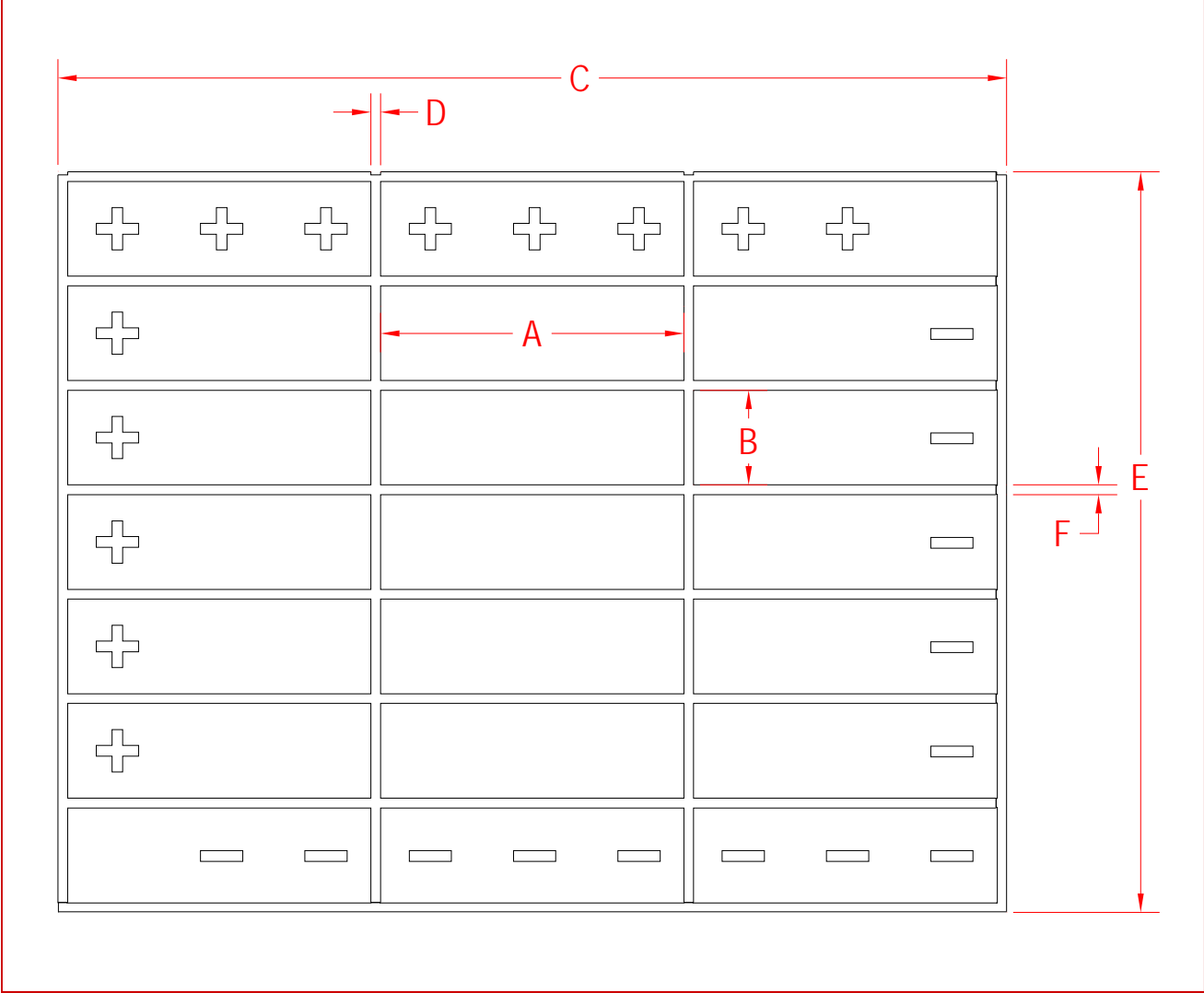

**Coverage / Piece**

Square Feet.... 7  
Linear Feet..... 3

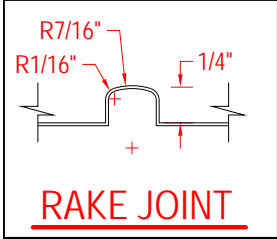

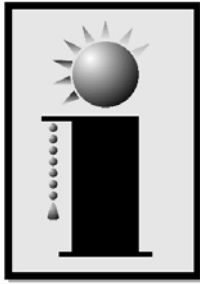

**INNOVATIVE**  
BRICK SYSTEMS, L.L.C.

**Innovative Brick Systems, L.L.C.**  
11625 Reed Ct.  
Broomfield, Co. 80020  
800-413-4588

**VersaLiner®**  
**#421 B**  
**Utility Stack Bond Rake 3X**

**Dimensions**

A... 11.640"  
B... 3.640  
C...\* 36 3/8"  
D... .360"  
E...\* 28 3/8"  
F... .360"

\* ±1/8" for normal thermal expansion and contraction

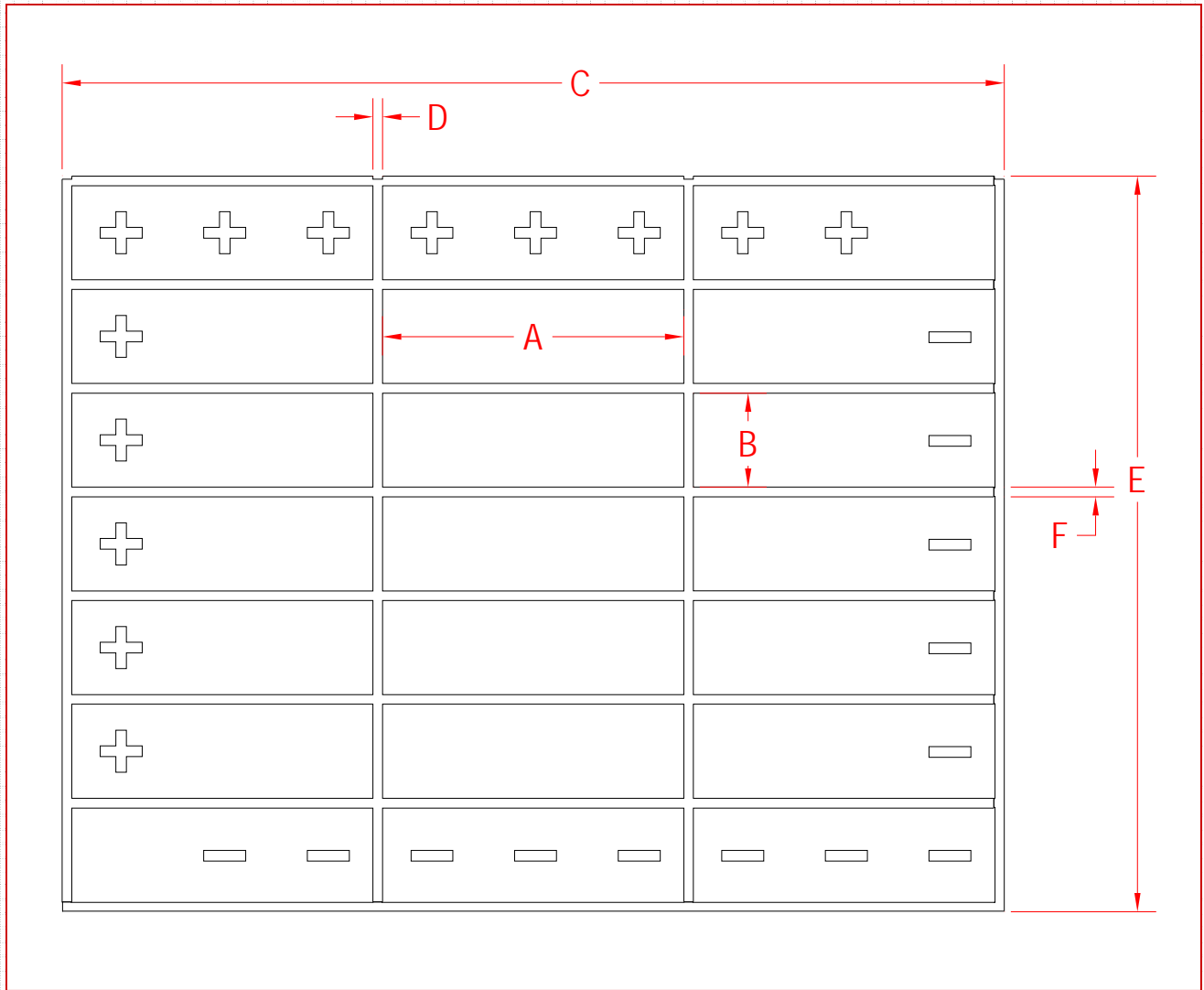

**Coverage / Piece**

Square Feet.... 7  
Linear Feet..... 3

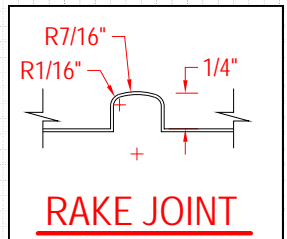

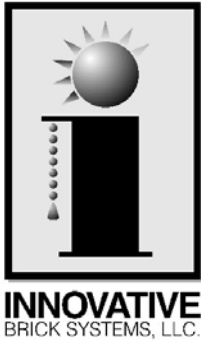

Innovative Brick Systems, L.L.C.  
11625 Reed Ct.  
Broomfield, Co. 80020  
800-413-4588

**Dimensions**  
 A... 11 5/8"  
 B... 3 5/8"  
 C...\* 36 3/8"  
 D... 3/8"  
 E...\* 24 3/8"  
 F... .3/8"  
 \* ±1/8" for normal thermal expansion and contraction

**VersaLiner®**  
**#422 Utility 1/2 Bond**  
**Rows 2/5 Recessed 3/8"**

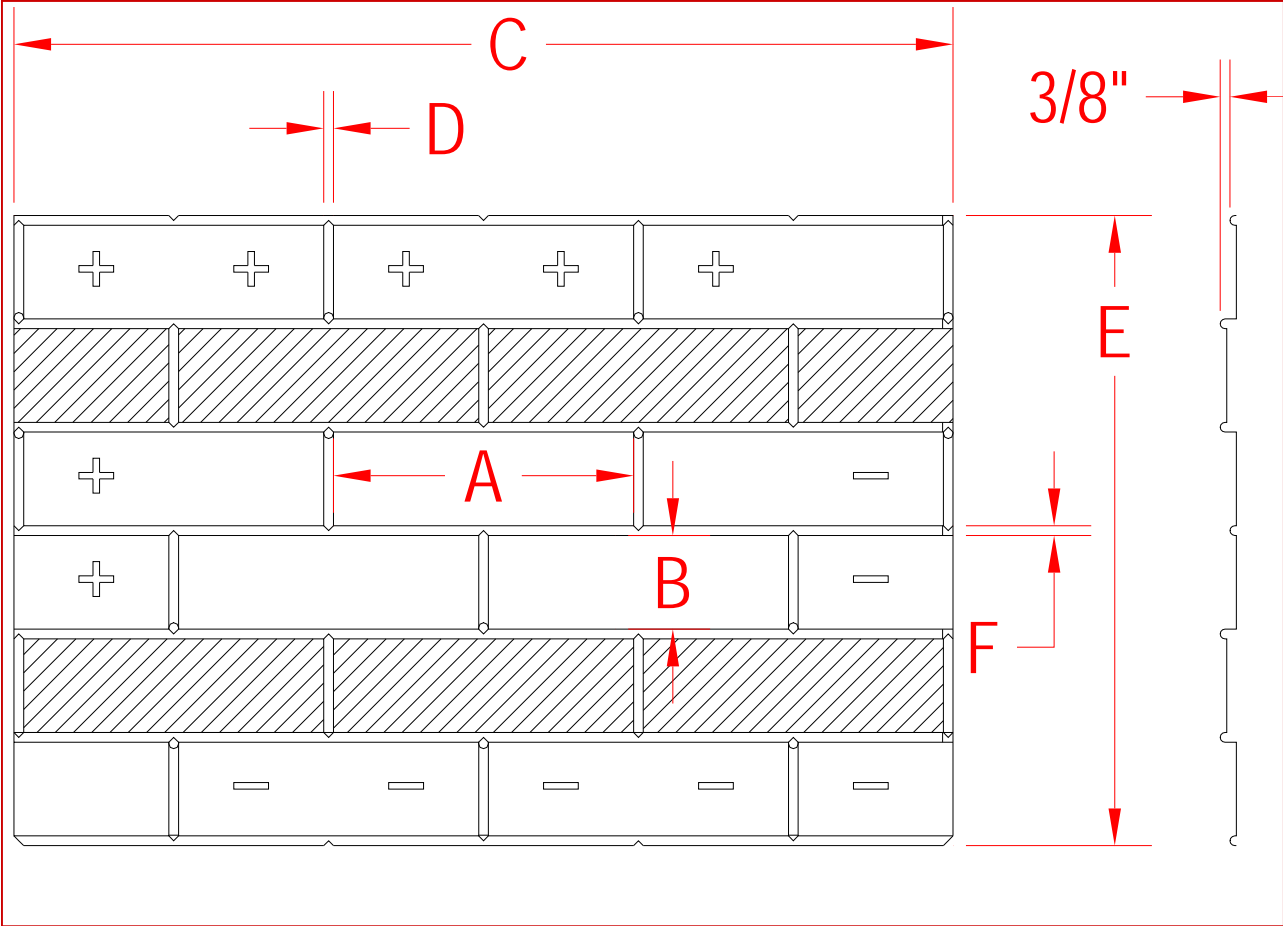

<b><u>Coverage / Piece</u></b>	
Square Feet....	6
Linear Feet.....	3

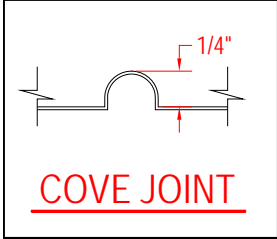

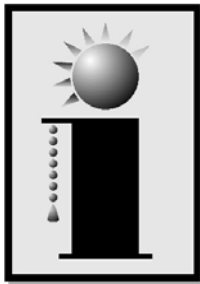

**INNOVATIVE**  
BRICK SYSTEMS, L.L.C.

**Innovative Brick Systems, L.L.C.**  
11625 Reed Ct.  
Broomfield, Co. 80020  
800-413-4588

**VersaLiner®**  
**#423 Utility 1/2 Bond**  
**Rows 3/4 Recessed 3/8"**

**Dimensions**

- A... 11 5/8"
- B... 3 5/8"
- C...\* 36 3/8"
- D... 3/8"
- E...\* 24 3/8"
- F... .3/8"

\* ±1/8" for normal thermal expansion and contraction

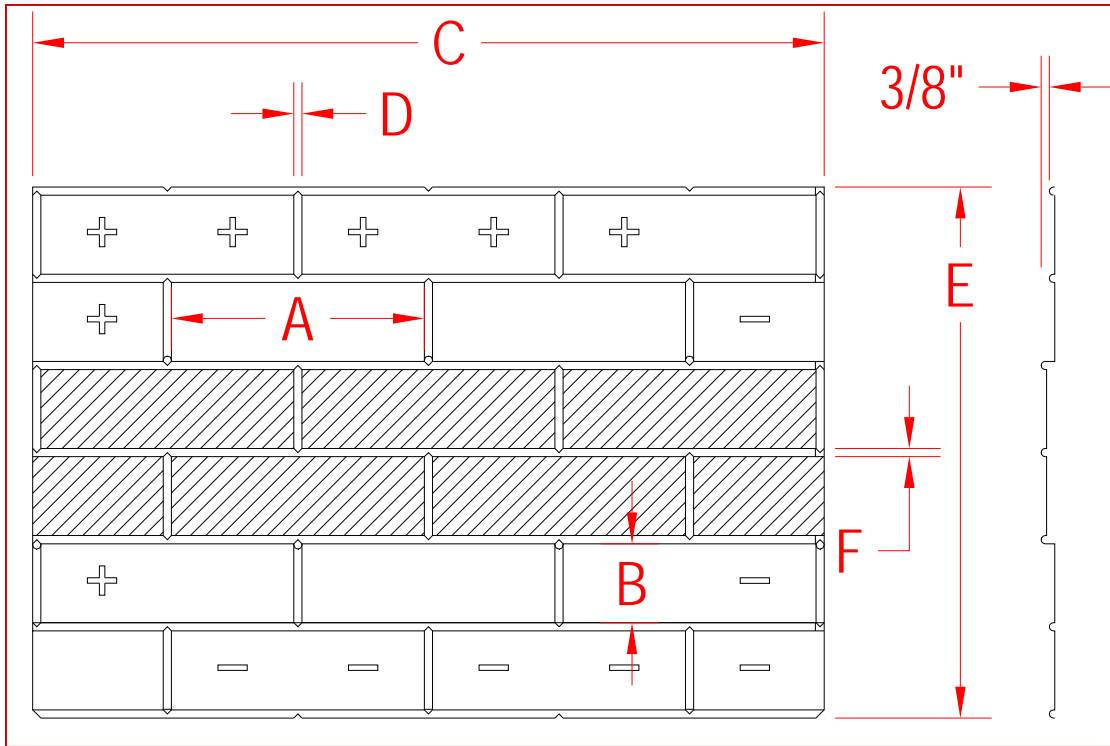

**Coverage / Piece**

Square Feet.... 6  
Linear Feet..... 3

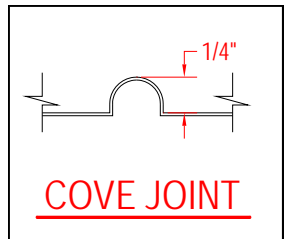

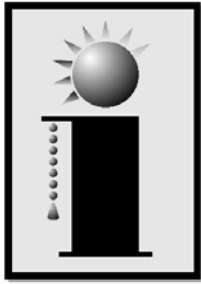

**INNOVATIVE**  
BRICK SYSTEMS, L.L.C.

Innovative Brick Systems, L.L.C.  
11625 Reed Ct.  
Broomfield, Co. 80020  
800-413-4588

**VersaLiner®**  
**#424 Utility 1/2 Bond**  
**1:1 Recessed 3/8"**

**Dimensions**

A... 11 5/8"  
B... 3 5/8"  
C...\* 36 3/8"  
D... 3/8"  
E...\* 24 3/8"  
F... 3/8"

\* ±1/8" for normal thermal expansion and contraction

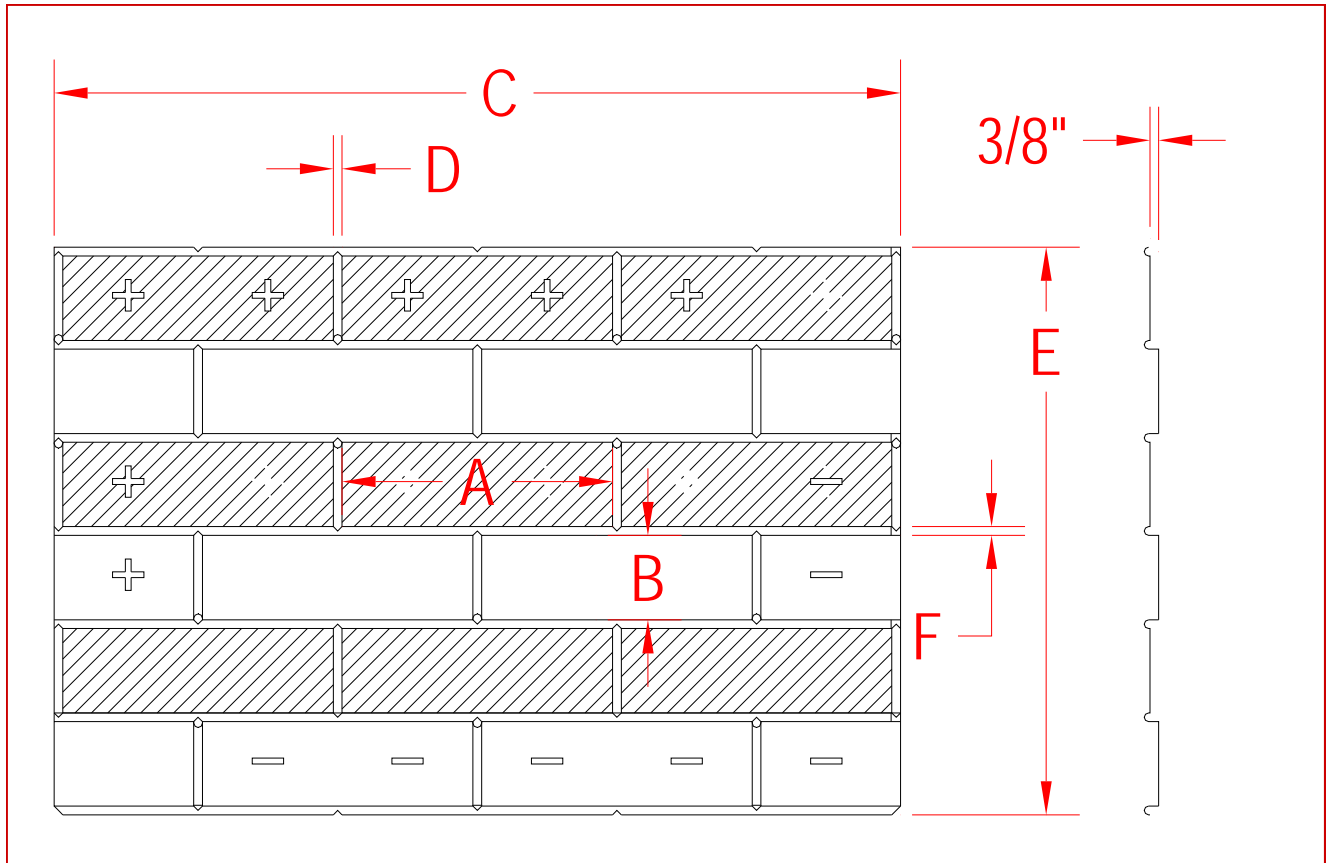

**Coverage / Piece**

Square Feet.... 6  
Linear Feet..... 3

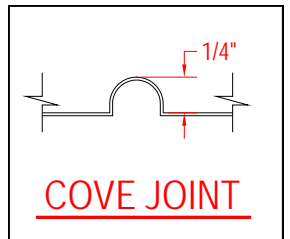

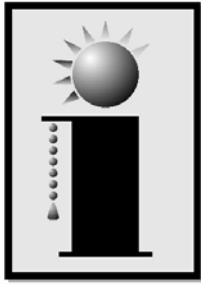

**INNOVATIVE**  
BRICK SYSTEMS, L.L.C.

**Innovative Brick Systems, L.L.C.**  
11625 Reed Ct.  
Broomfield, Co. 80020  
800-413-4588

**VersaLiner®**  
**#425 Utility**  
**Single Row Soldier**

**Dimensions**

A... 3 5/8"  
B... 11 5/8"  
C...\* 36 3/8"  
D... 3/8"  
E...\* 12 3/8"  
F... 3/8"

\* ±1/8" for normal thermal expansion and contraction

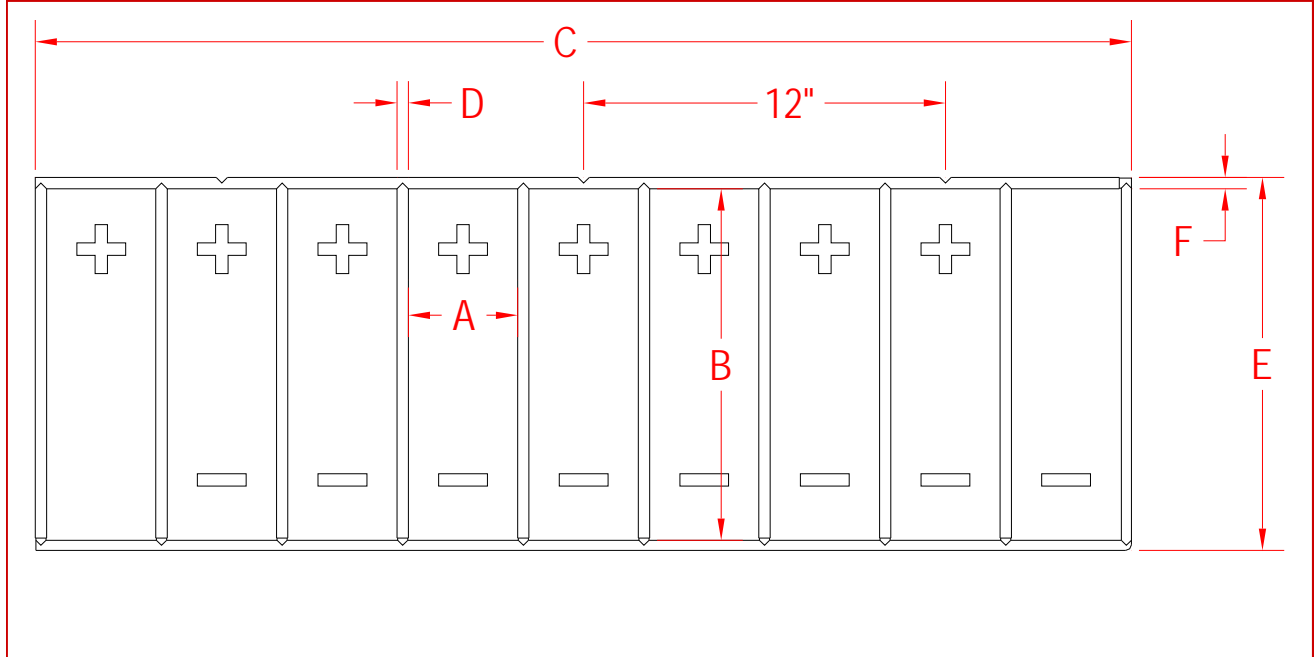

**FINISHED PATTERN (RED)**

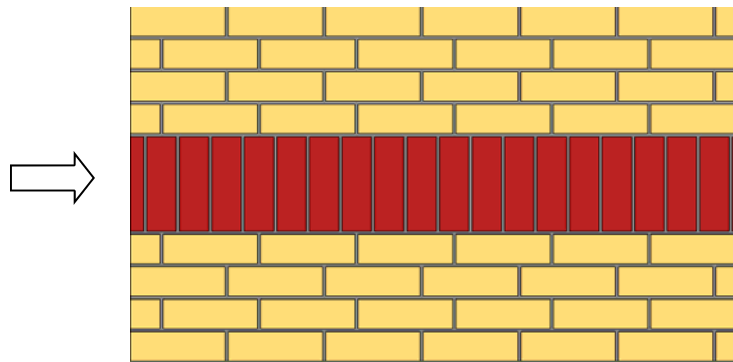

**Coverage / Piece**

Square Feet.... 3  
Linear Feet..... 3

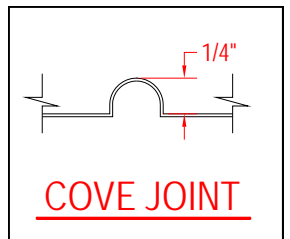

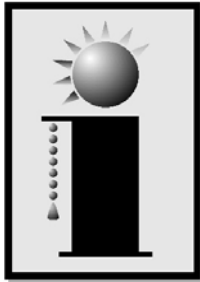

**INNOVATIVE**  
BRICK SYSTEMS, L.L.C.

**Innovative Brick Systems, L.L.C.**  
11625 Reed Ct.  
Broomfield, Co. 80020  
800-413-4588

**VersaLiner®**  
**#453 3 Row (4x4)**

**Dimensions**

- A... 3 5/8"
- B... 3 5/8"
- C...\* 36 3/8"
- D... 3/8"
- E...\* 12 3/8"
- F... 3/8"

\* ±1/8" for normal thermal expansion and contraction

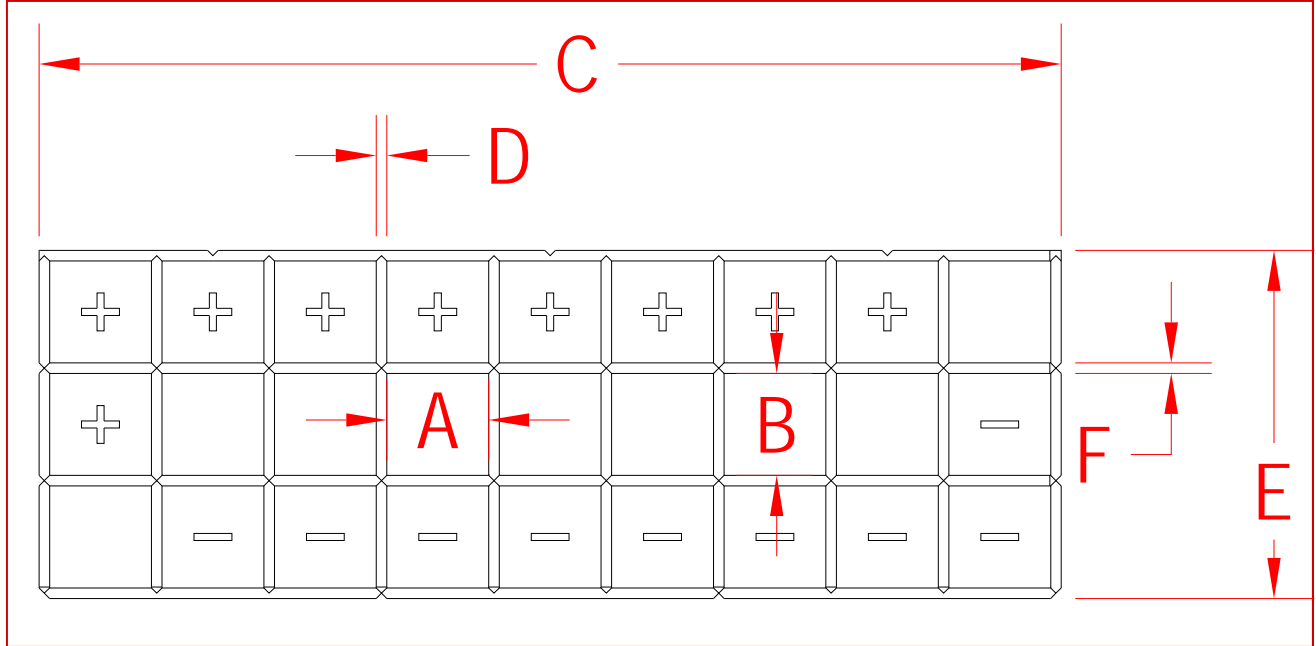

**Finished Pattern (yellow)**

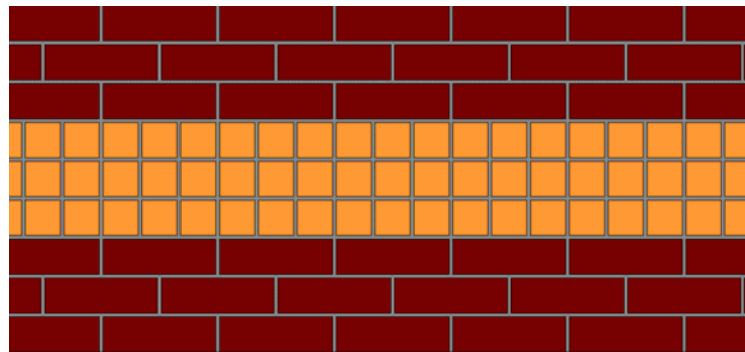

**Coverage / Piece**

Square Feet.... 3  
Linear Feet..... 3

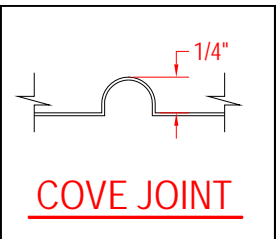

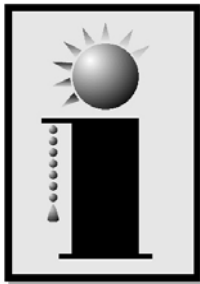

**INNOVATIVE**  
BRICK SYSTEMS, L.L.C.

Innovative Brick Systems, L.L.C.  
11625 Reed Ct.  
Broomfield, Co. 80020  
800-413-4588

## VersaLiner® #470 Utility Herringbone

### Dimensions

A... 11.640"  
B... 3.640"  
C...\* 20 5/16"  
D... .360"  
E...\* 37 5/16"  
F... .36"

\* ±1/8" for normal thermal expansion and contraction

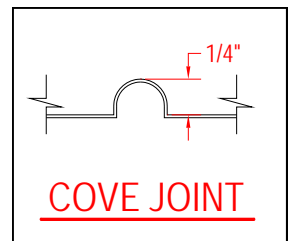
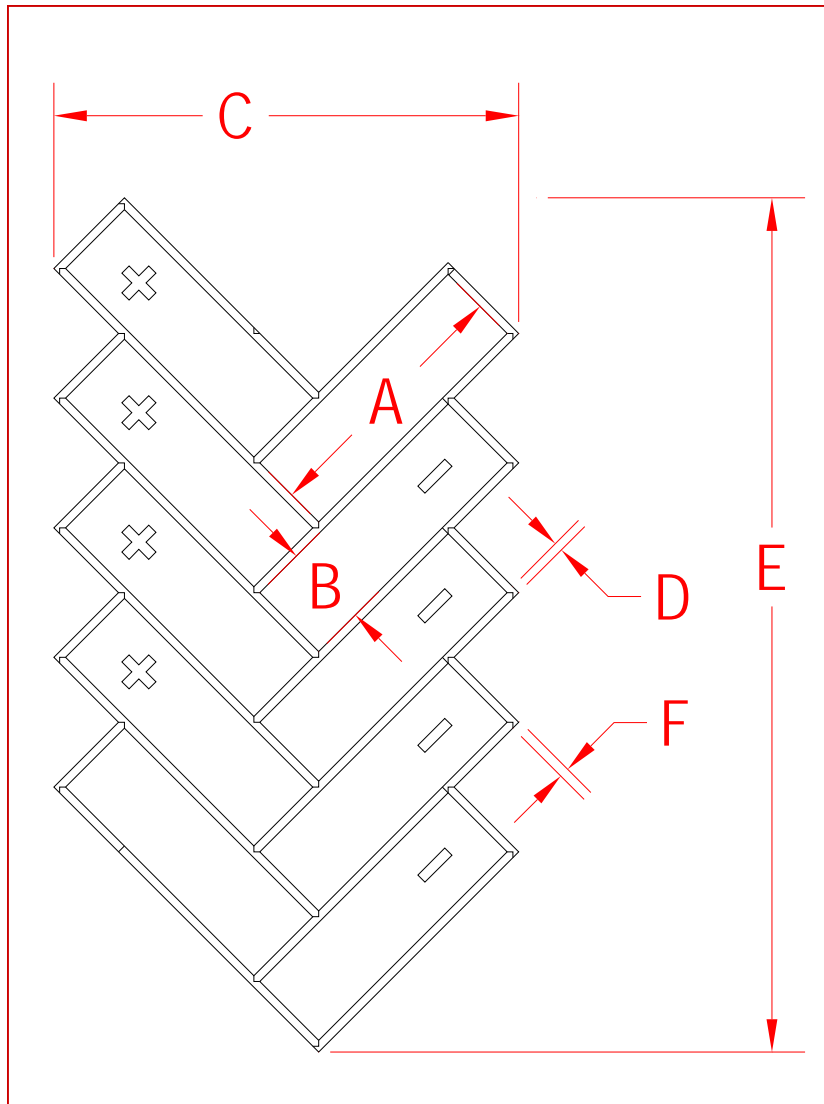

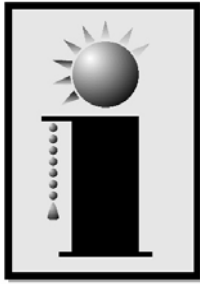

**INNOVATIVE**  
BRICK SYSTEMS, L.L.C.

**Innovative Brick Systems, L.L.C.**  
11625 Reed Ct.  
Broomfield, Co. 80020  
800-413-4588

**VersaLiner®**  
**#5403**  
**Utility 1/3 Bond Rake**

**Dimensions**  
A... 11 11/16"  
B... 3 11/16"  
C...\* 36 3/8"  
D... 5/16"  
E...\* 24 3/8"  
F... 5/16"

\* ±1/8" for normal thermal expansion and contraction

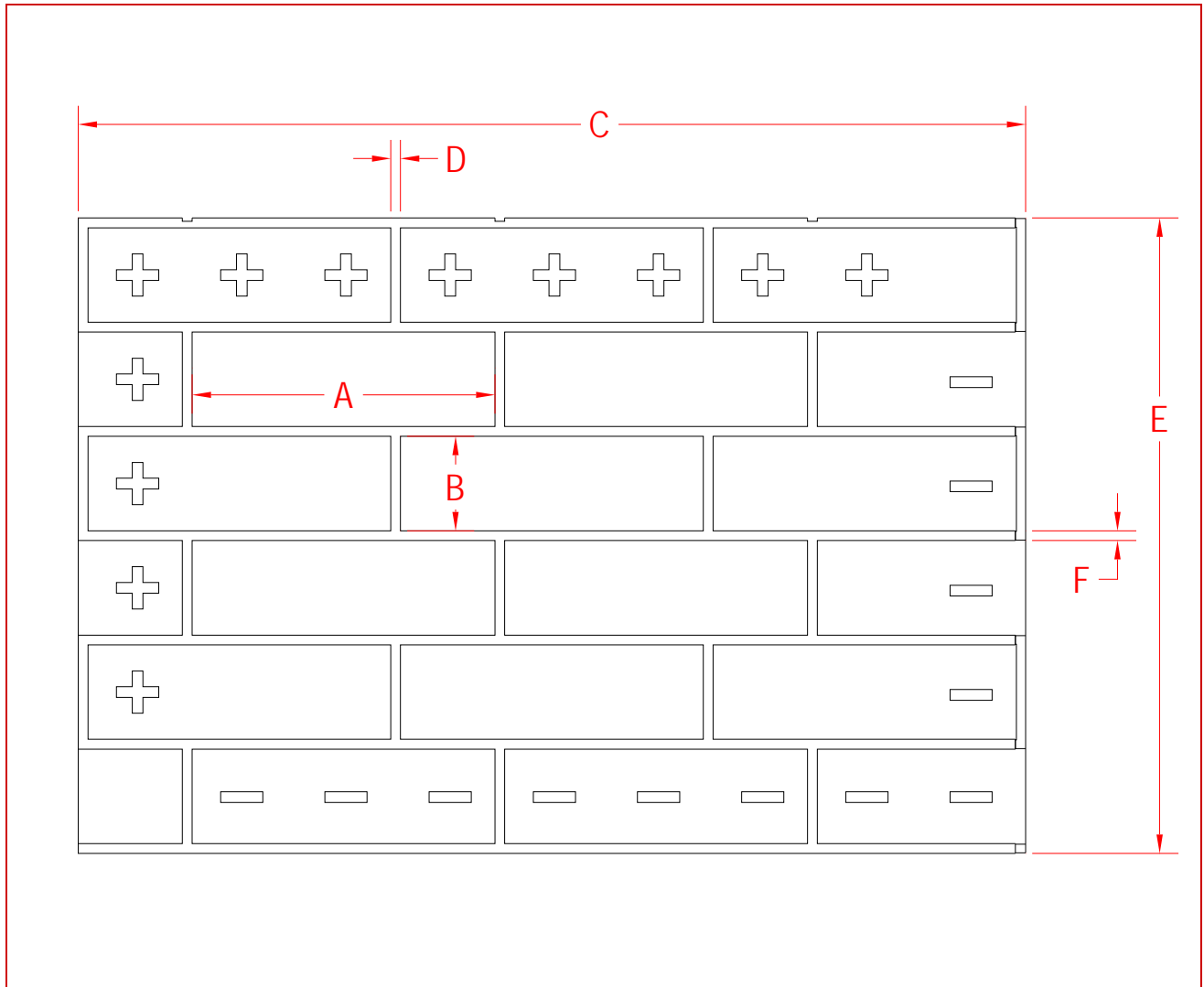

**Coverage / Piece**

Square Feet.... 6  
Linear Feet..... 3

**Shipping Info**

Box size .. 7"x28"x37"  
Pcs per box .... 30  
Box weight ... 24 lbs  
SF per box ..... 180

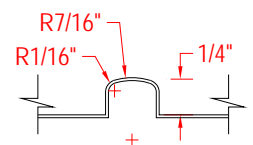

**RAKE JOINT**

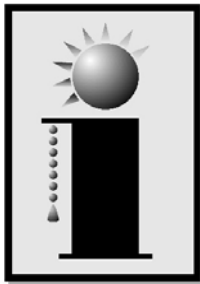

**INNOVATIVE**  
BRICK SYSTEMS, L.L.C.

**Innovative Brick Systems, L.L.C.**  
11625 Reed Ct.  
Broomfield, Co. 80020  
800-413-4588

**VersaLiner®**  
**#810 Split-Face Block**  
**8x16 1/2 Bond**

**Dimensions**

A... 15 5/8"  
B... 7 5/8"  
C...\* 16"  
D... 3/8"  
E...\* 32"  
F... 3/8"

\* ±1/8" for normal thermal expansion and contraction

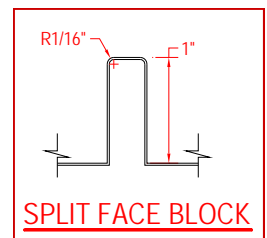
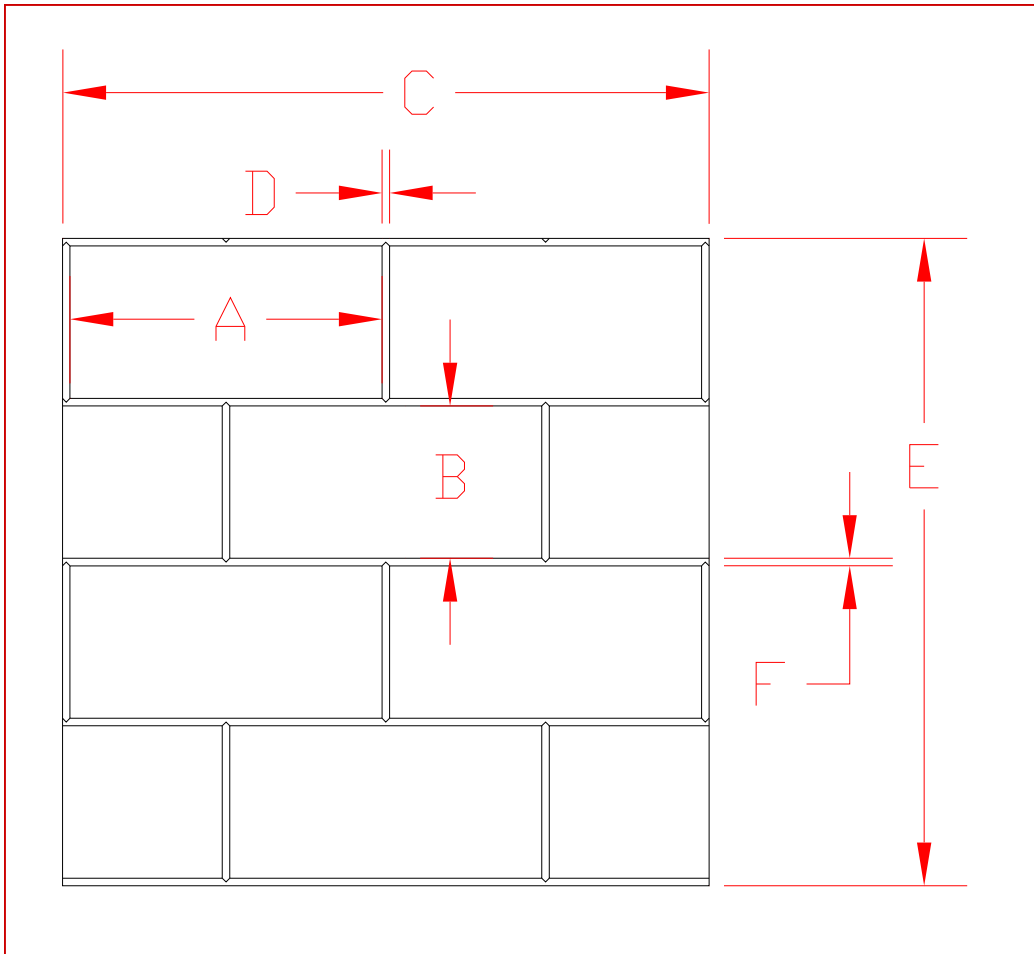

Integral "crush pad" mated to each stone when shipped.

**Coverage / Piece**

Square Feet.... 7.11  
Linear Feet..... 2.67

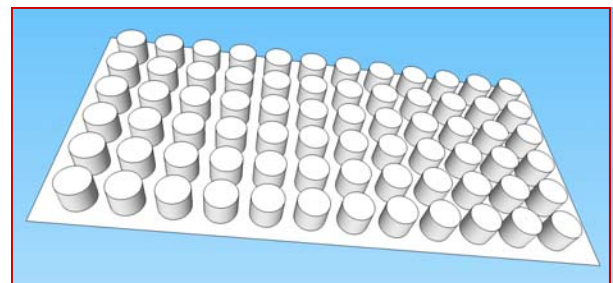

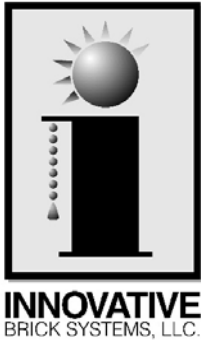

Innovative Brick Systems, L.L.C.  
 11625 Reed Ct.  
 Broomfield, Co. 80020  
 800-413-4588

**VersaLiner®**  
**#822 4x24 12x24**  
**Offset Bond w/1/4" Joint**

**Dimensions**  
 A... 23 1/2"  
 B... 11 11/16"  
 C...\* 28"  
 D... 1/2"  
 E...\* 48"  
 F... 1/4"  
 G... 3 13/16"  
 \* ±1/8" for normal thermal expansion and contraction

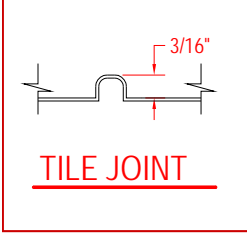
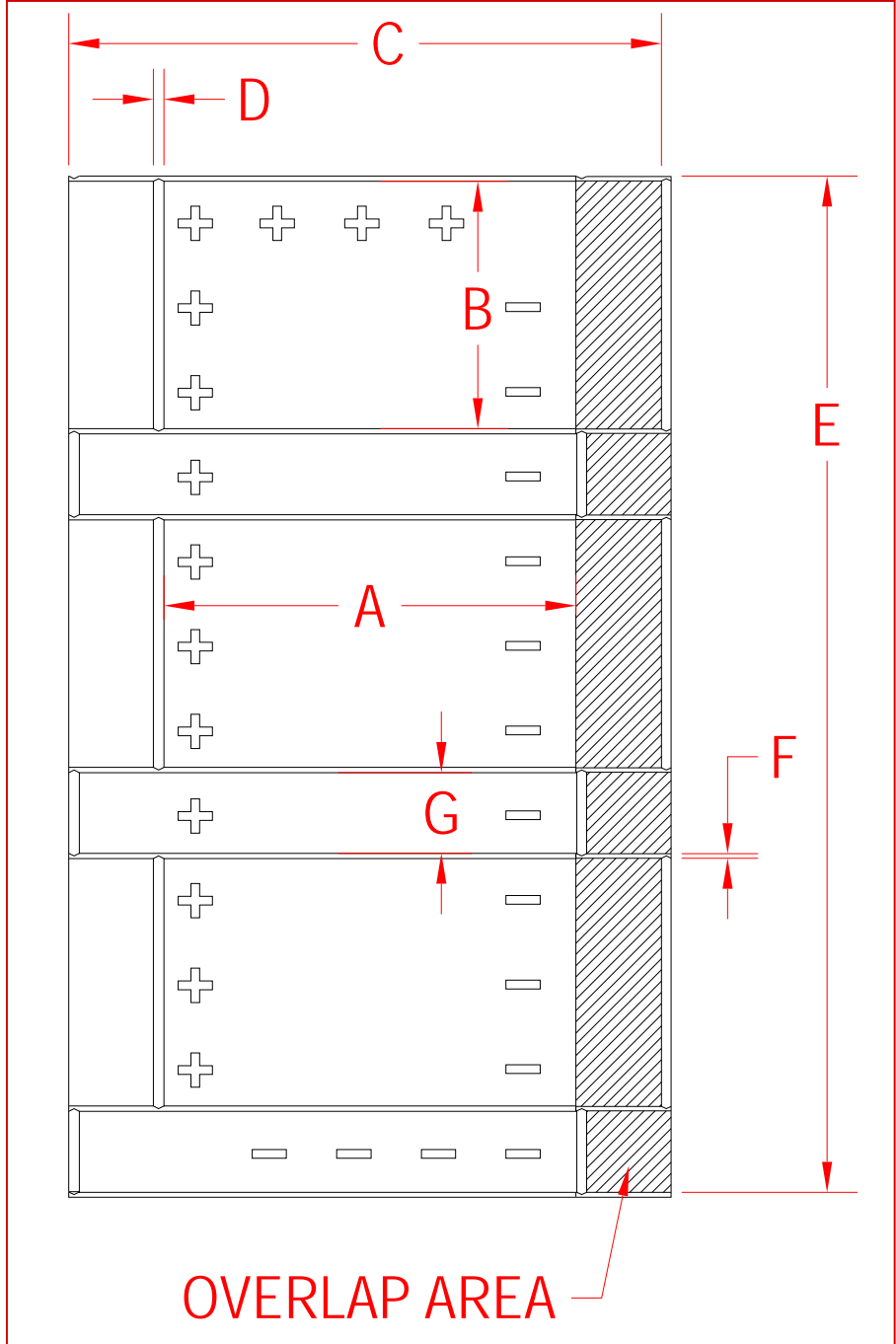

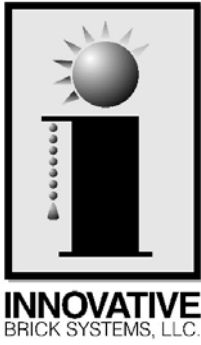

**Innovative Brick Systems, L.L.C.**  
11625 Reed Ct.  
Broomfield, Co. 80020  
800-413-4588

**Dimensions**  
 $L = 32 \frac{3}{8}"$   
 $W = 32 \frac{3}{8}"$

\*  $\pm 1/8"$  for normal thermal expansion and contraction

**VersaLiner®**  
**#830 8x8**  
**Stack Bond**

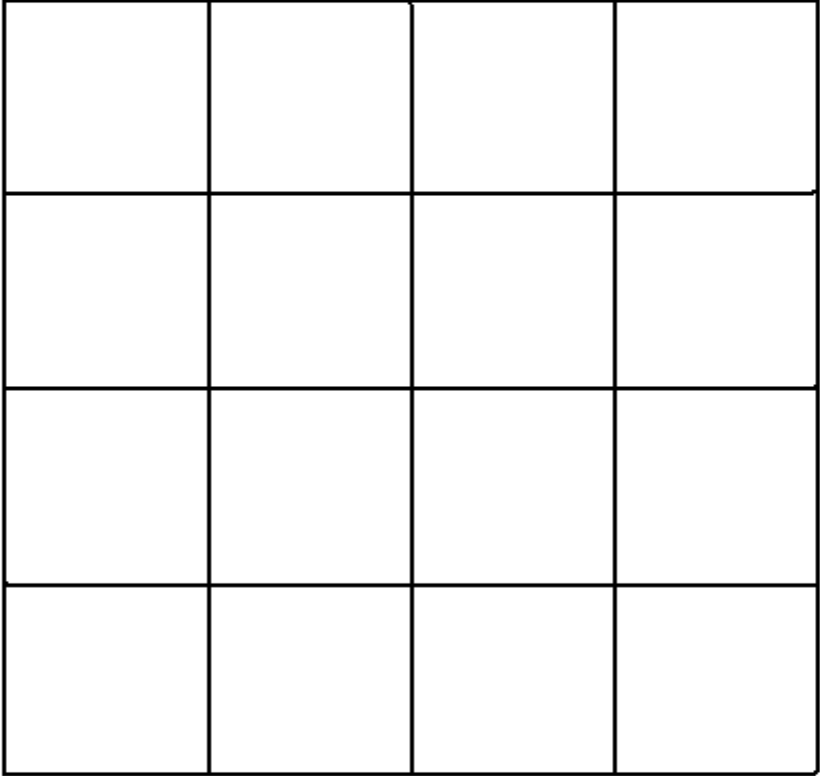

Joints are the same in both directions (3/8")

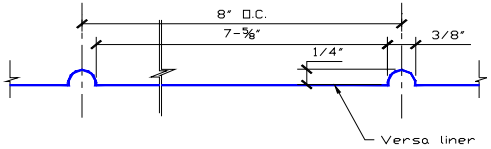

**Coverage / Piece**

*Square Feet.... 7.11*  
*Linear Feet..... 2.66*



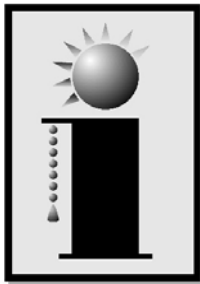

**INNOVATIVE**  
BRICK SYSTEMS, L.L.C.

**Innovative Brick Systems, L.L.C.**  
11625 Reed Ct.  
Broomfield, Co. 80020  
800-413-4588

**VersaLiner®**  
**#860 Versa-Stone**  
**Base**

**Dimensions**

- A... 15 5/8"
- B... 7 5/8"
- C...\* 48"
- D... 3/8"
- E...\* 32"
- F... 3/8"

\* ±1/8" for normal thermal expansion and contraction

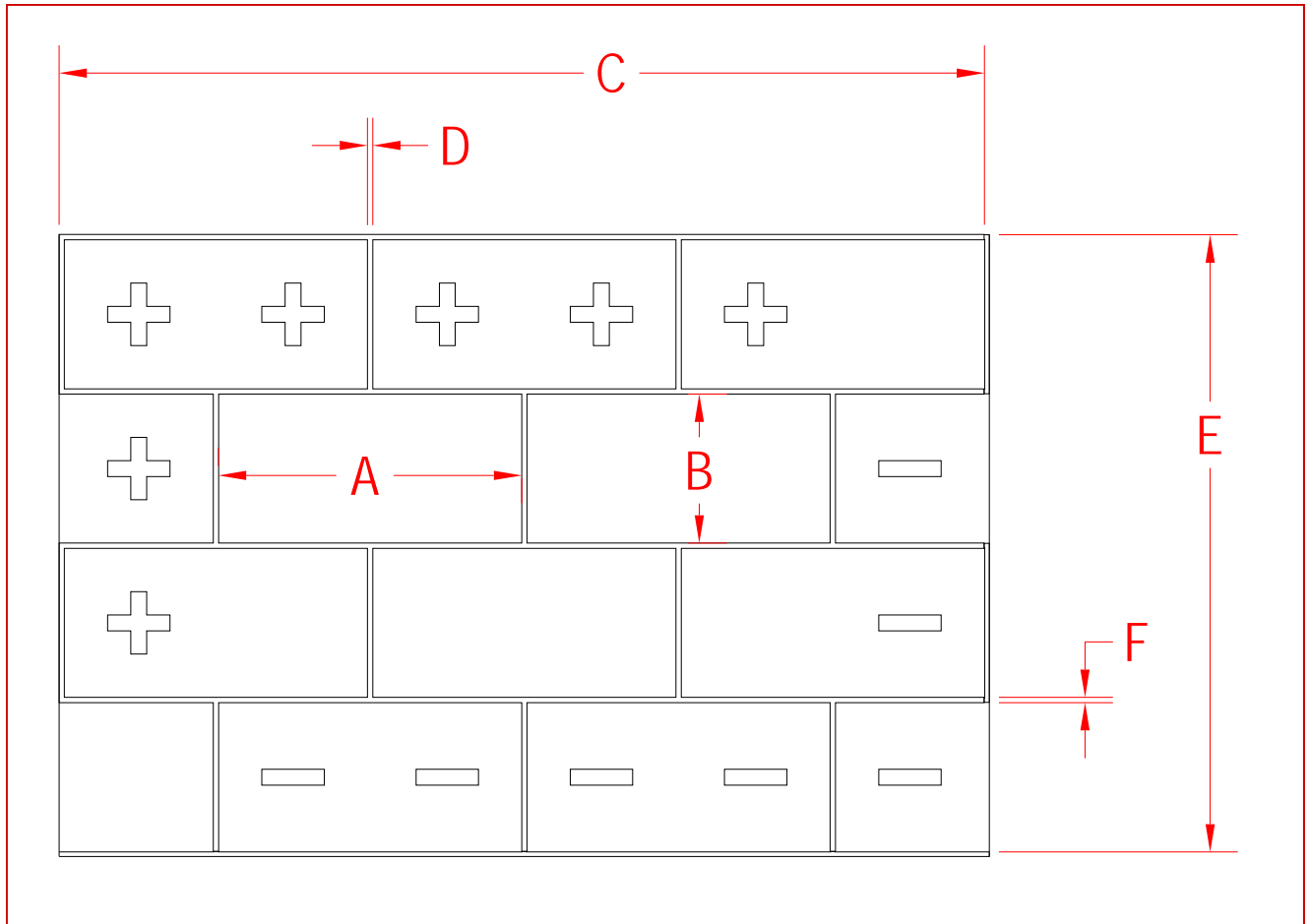

<b><u>Coverage / Piece</u></b>	
Square Feet....	8.89
Linear Feet....	4.00

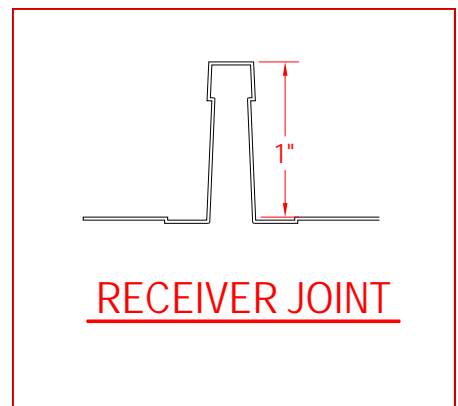

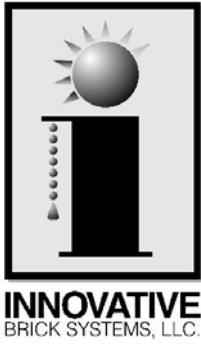

**Innovative Brick Systems, L.L.C.**  
11625 Reed Ct.  
Broomfield, Co. 80020  
800-413-4588

***Dimensions***  
A... 3.74"  
B... 1.77"  
C...\* 39.37"  
D... .197"  
E...\* 23.62"  
F... .197"  
\* ±1/8" for normal thermal expansion and contraction

**VersaLiner®**  
**#870 Metallic Brick**  
**Running Bond**

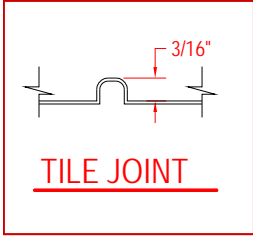
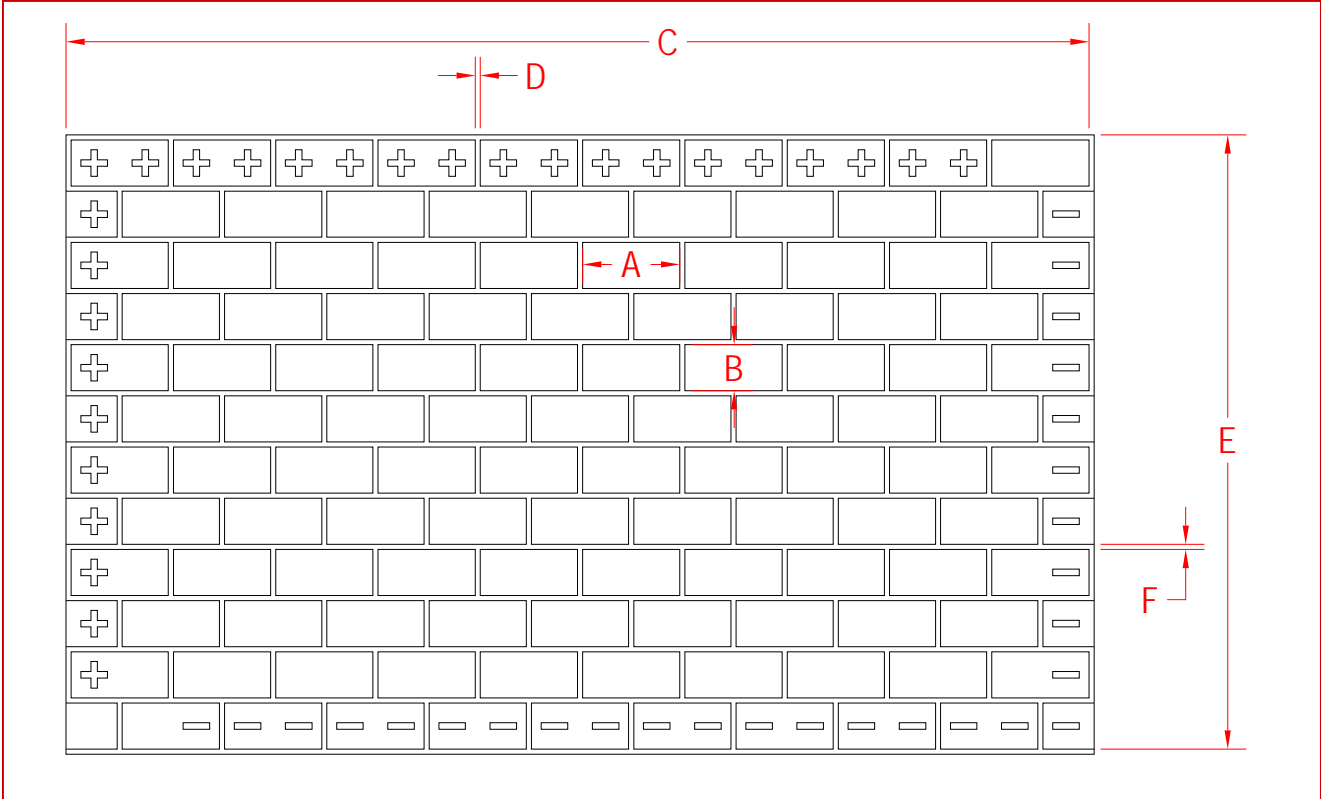

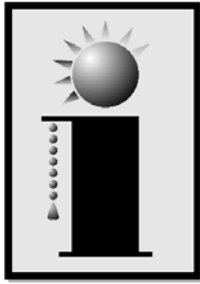

**INNOVATIVE**  
BRICK SYSTEMS, L.L.C.

**Innovative Brick Systems, L.L.C.**  
11625 Reed Ct.  
Broomfield, Co. 80020  
800-413-4588

**VersaLiner®**  
**#870M Metallic Brick**  
**Running Bond**

**Dimensions**

- A... 95mm
- B... 45mm
- C...\* 1000mm
- D... 5mm
- E...\* 600mm
- F... 5mm

\* ±4mm for normal thermal expansion and contraction

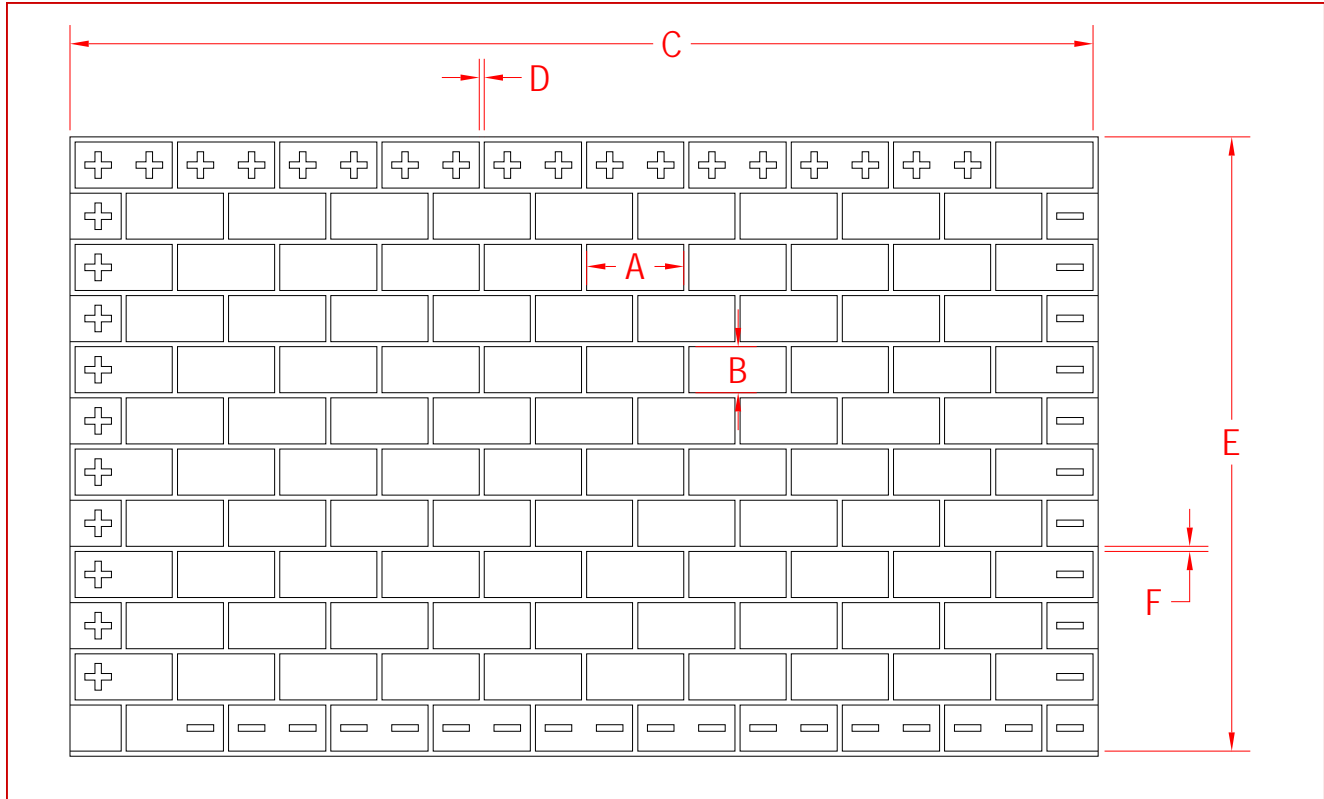

**Coverage per piece**  
Square M.... .6  
Linear M..... 1

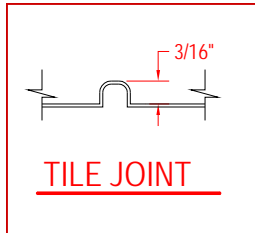

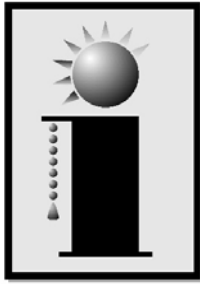

**INNOVATIVE**  
BRICK SYSTEMS, LLC.

**Innovative Brick Systems, L.L.C.**  
11625 Reed Ct.  
Broomfield, Co. 80020  
800-413-4588

**VersaLiner®**  
**#871M Metallic Brick**  
**Stacked Bond**

**Dimensions**

A... 395mm  
B... 45mm  
C...\* 1000mm  
D... 5mm  
E...\* 600mm  
F... 5mm

\* ±4mm for normal thermal expansion and contraction

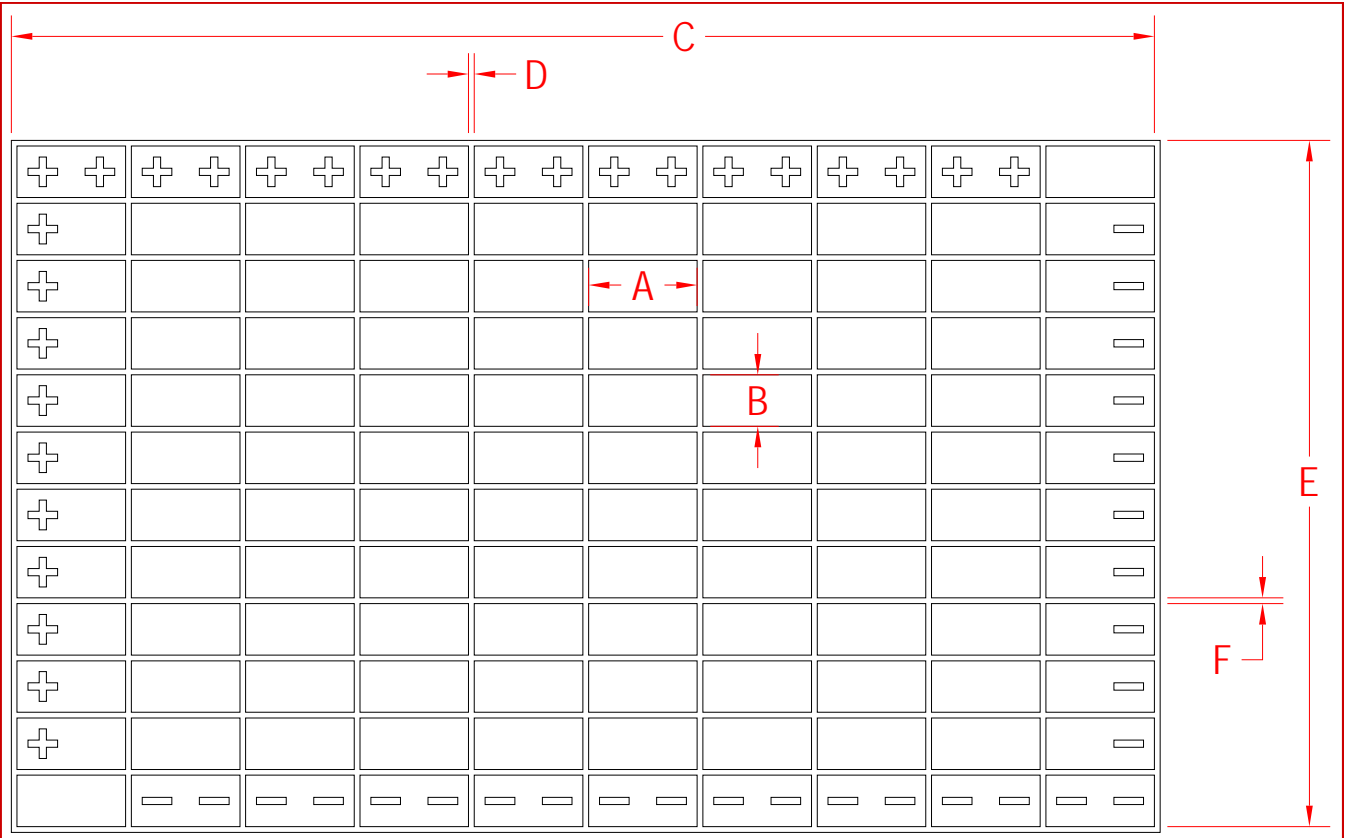

**Coverage per piece**

Square M.... .6  
Linear M..... 1

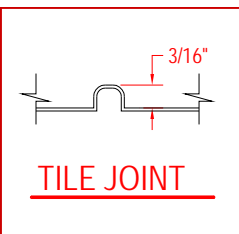

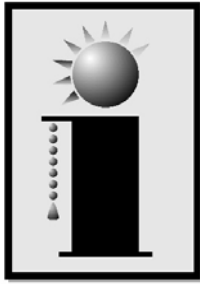

**INNOVATIVE**  
BRICK SYSTEMS, L.L.C.

**Innovative Brick Systems, L.L.C.**  
11625 Reed Ct.  
Broomfield, Co. 80020  
800-413-4588

**VersaLiner®**  
**#871 Metallic Brick**  
**Stacked Bond**

**Dimensions**

A... 3.74"  
B... 1.77"  
C...\* 39.37"  
D... .197"  
E...\* 23.62"  
F... .197"

\* ±1/8" for normal thermal expansion and contraction

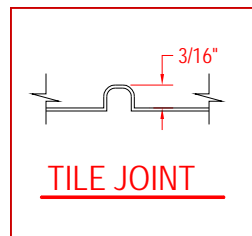
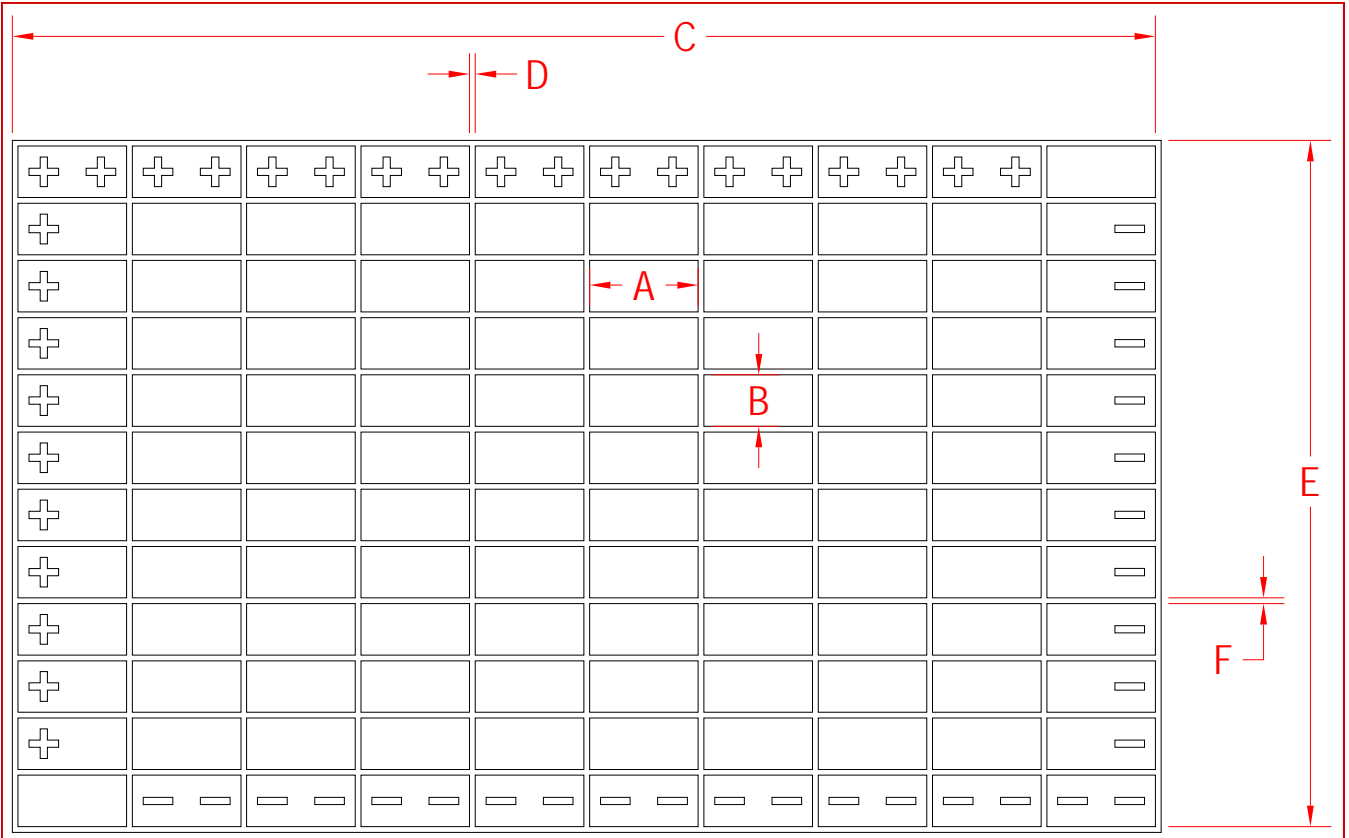

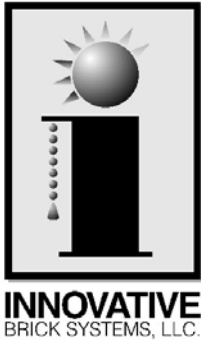

Innovative Brick Systems, L.L.C.  
11625 Reed Ct.  
Broomfield, Co. 80020  
800-413-4588

**Dimensions**  
 A... 7.64"  
 7 5/8" Nom  
 B... 2.82"  
 2 3/4" Nom  
 C...\* 40"  
 D... 1/2" Nom  
 E...\* 24"  
 F... 1/4" Nom

\* ±1/8" for normal thermal expansion and contraction

**VersaLiner®**  
**#S 203 Special 2 3/4 x 7 5/8**  
**Running Bond CFTJ**

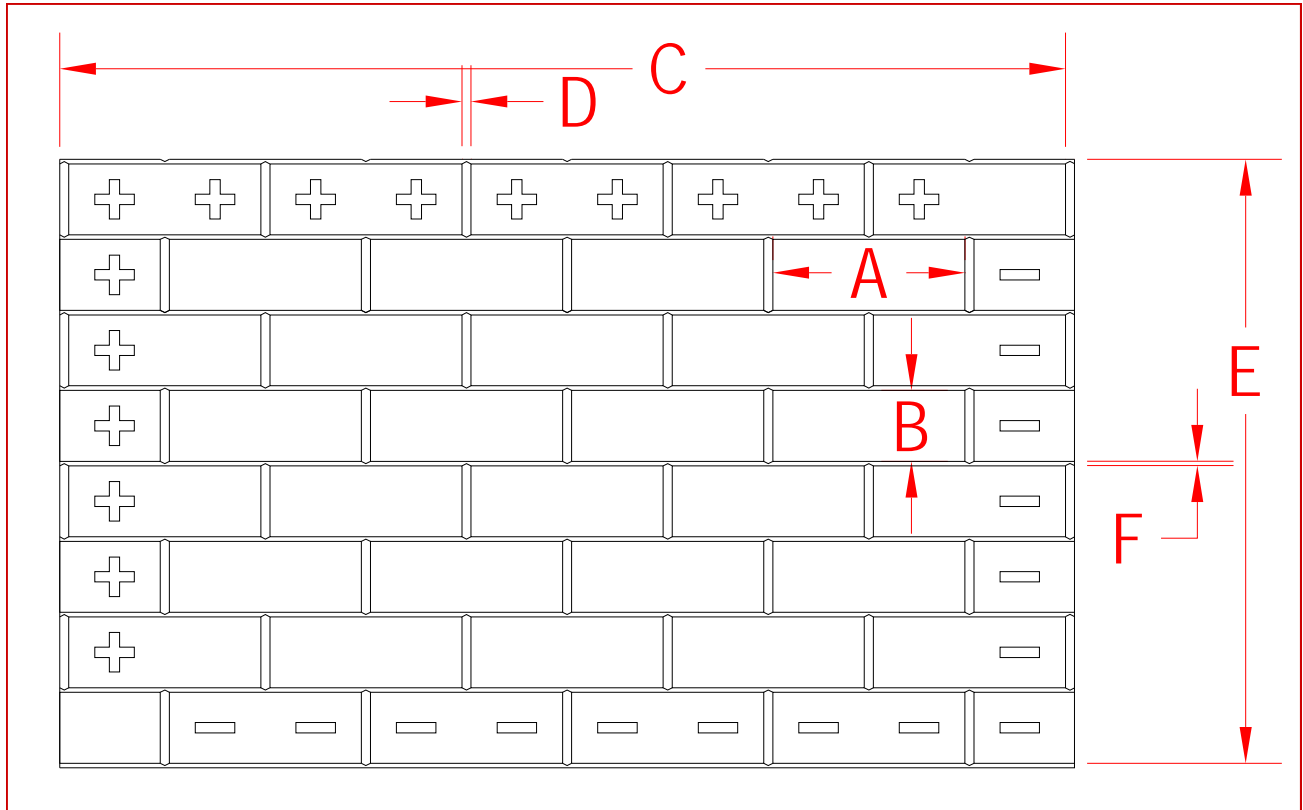

**CFTJ - \*joint is "compression fit" textured**

**Coverage / Piece**

Square Feet.... 6.67  
 Linear Feet..... 3.33

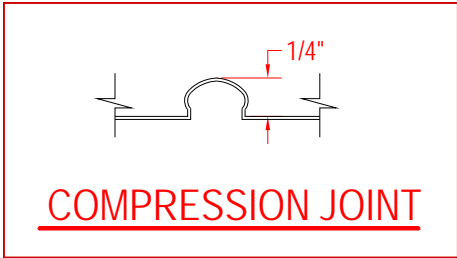

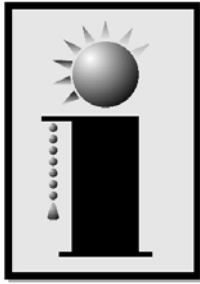

**INNOVATIVE**  
BRICK SYSTEMS, L.L.C.

Innovative Brick Systems, L.L.C.  
11625 Reed Ct.  
Broomfield, Co. 80020  
800-413-4588

**VersaLiner®**  
**#S 310 King 3 5/8 x 9 5/8**  
**1/3 Bond TJ\***

**Dimensions**

A... 9 5/8"  
B... 2 5/8"  
C...\* 40"  
D... 3/8"  
E...\* 24"  
F... 3/8"

\* ±1/8" for normal thermal expansion and contraction

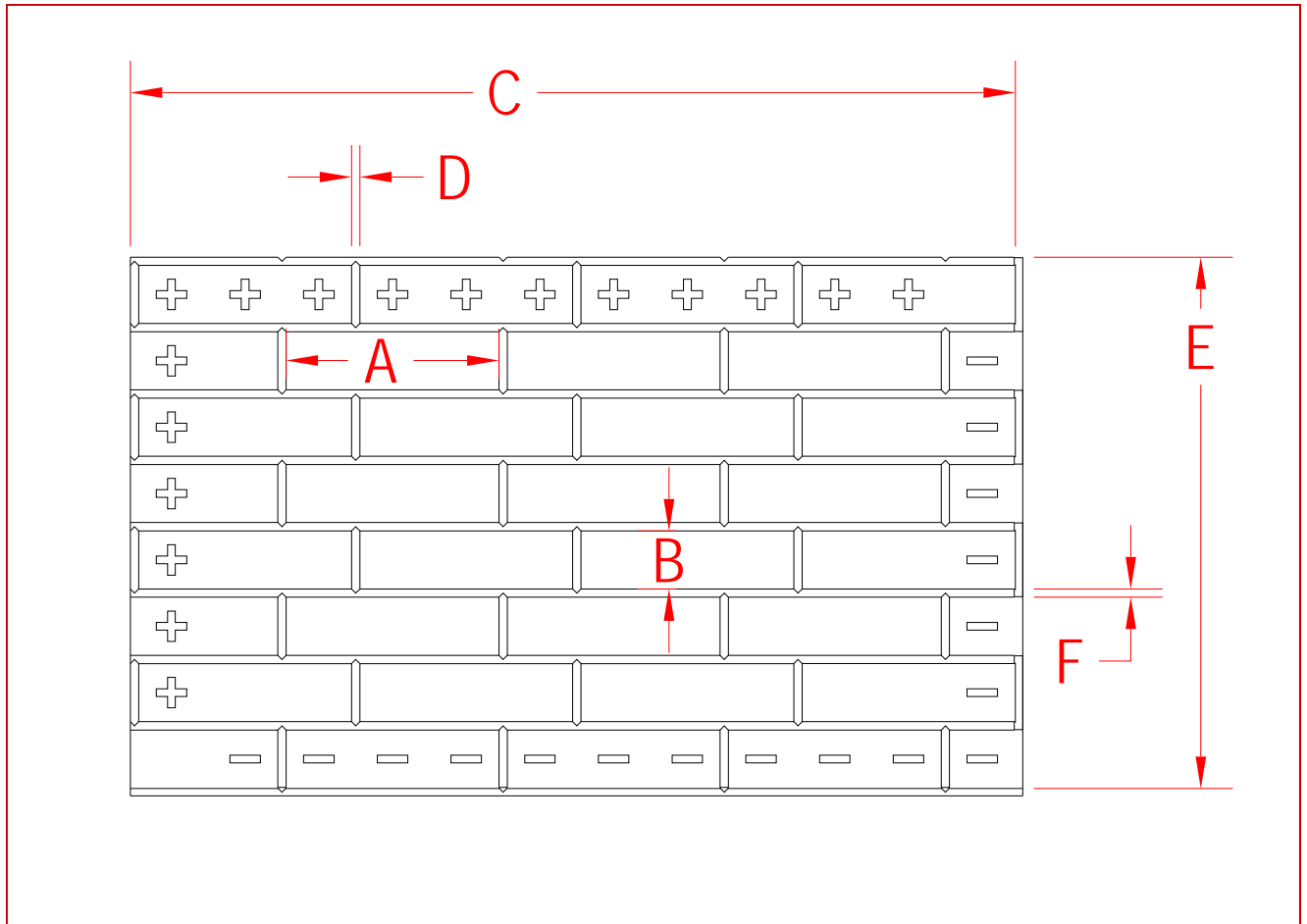

\* Joint is cove joint with texture

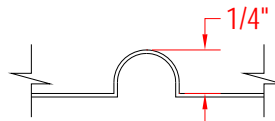

**COVE JOINT**

**Coverage / Piece**

Square Feet... 6.67  
Linear Feet.... 3.33



102809

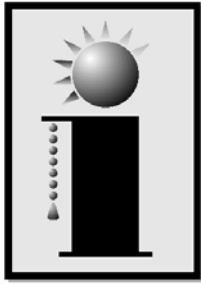

**INNOVATIVE**  
BRICK SYSTEMS, L.L.C.

Innovative Brick Systems, L.L.C.  
11625 Reed Ct.  
Broomfield, Co. 80020  
800-413-4588

**VersaLiner®**  
**#S701- 3 3/8" x 11 1/4"**  
**Third Bond**

**Dimensions**

A... 11 1/4"  
B... 3 3/8"  
C...\* 35 1/4"  
D... 3/8"  
E...\* 20 7/8"  
F... 3/8"

\* ±1/8" for normal thermal expansion and contraction

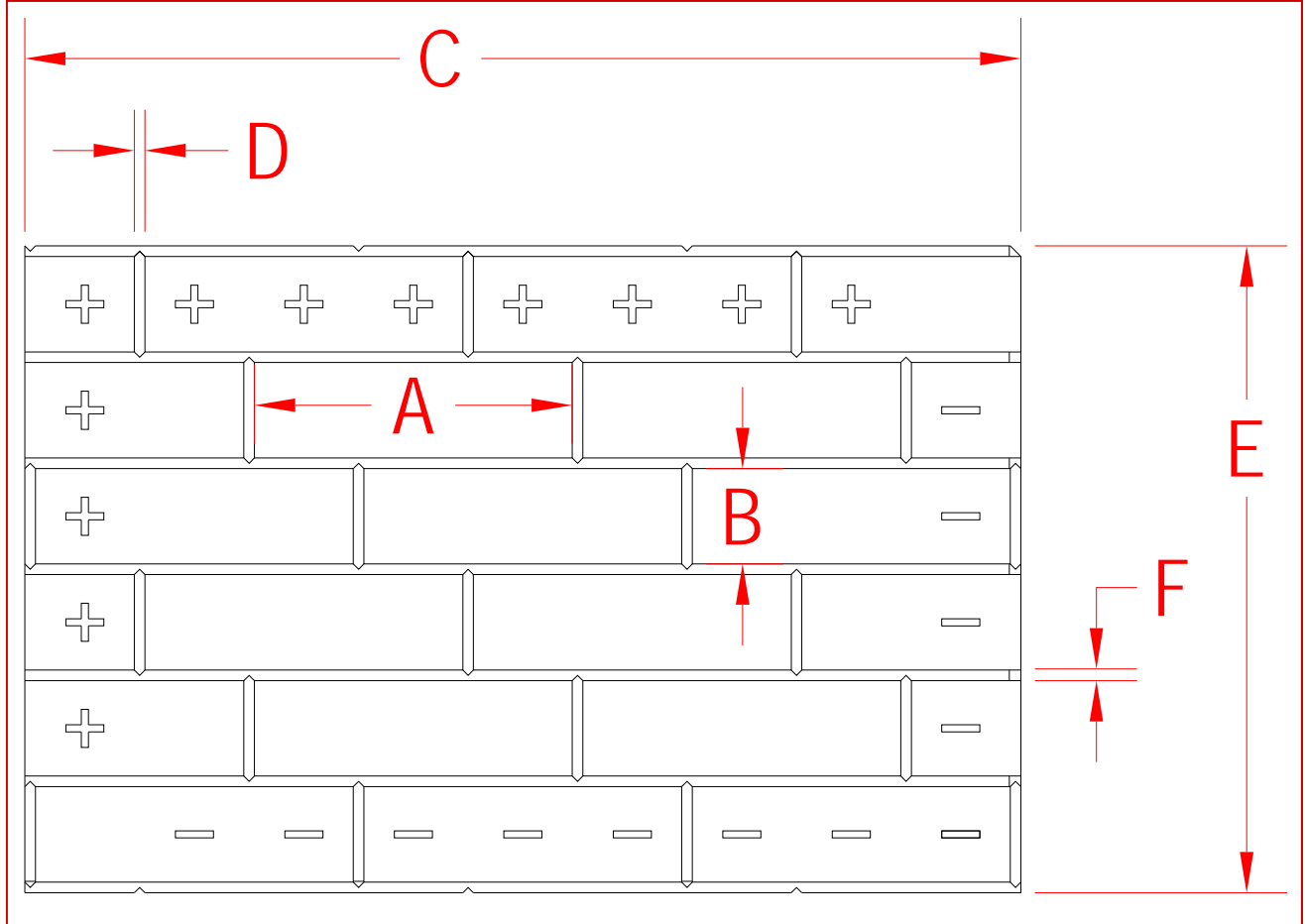

**Coverage / Piece**

Square Feet.... 4.97  
Linear Feet..... 2.91

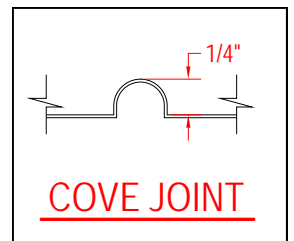

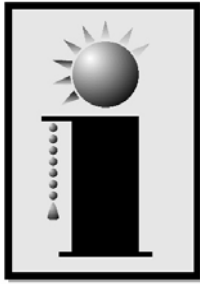

**INNOVATIVE**  
BRICK SYSTEMS, L.L.C.

**Innovative Brick Systems, L.L.C.**  
11625 Reed Ct.  
Broomfield, Co. 80020  
800-413-4588

**VersaLiner®**  
**#S702 1 5/8" x 11 5/8"**  
**Roman 1/3 Bond**

**Dimensions**

- A... 11 5/8"
- B... 1 5/8"
- C...\* 36 3/8"
- D... 3/8"
- E...\* 28 3/8"
- F... .3/8"

\* ±1/8" for normal thermal expansion and contraction

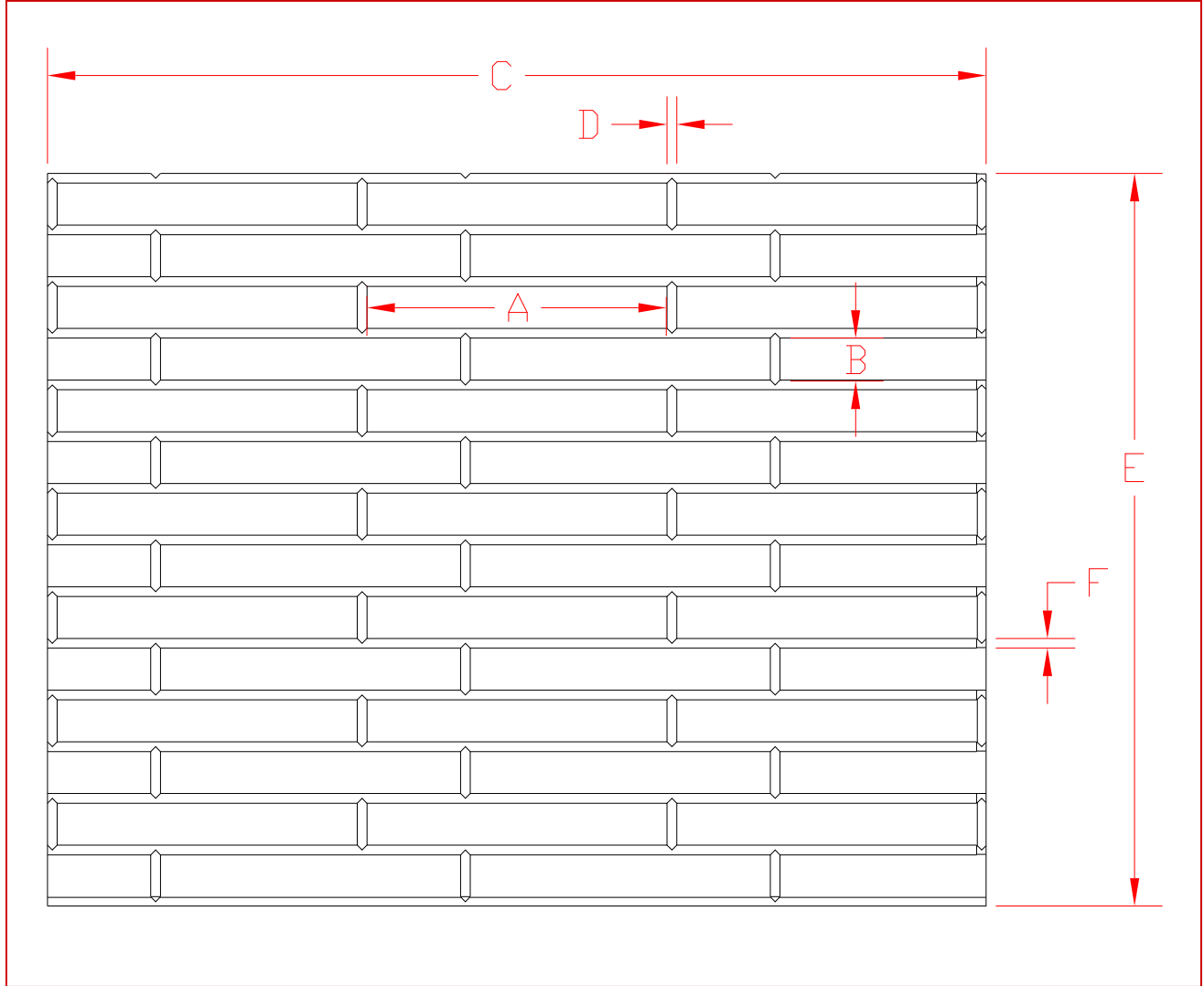

**Coverage / Piece**

Square Feet.... 7  
Linear Feet..... 3

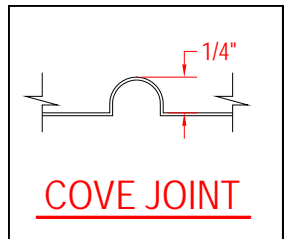

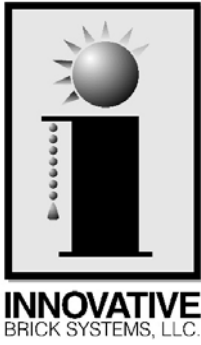

Innovative Brick Systems, L.L.C.  
 11625 Reed Ct.  
 Broomfield, Co. 80020  
 800-413-4588

**Dimensions**  
 A... 15 9/16"  
 B... 3 9/16"  
 C...\* 48"  
 D... 7/16"  
 E...\* 40"  
 F... 7/16"  
 \* ±1/8" for normal thermal expansion and contraction

**VersaLiner®**  
**#416**  
**4x16 1/2 Bond**

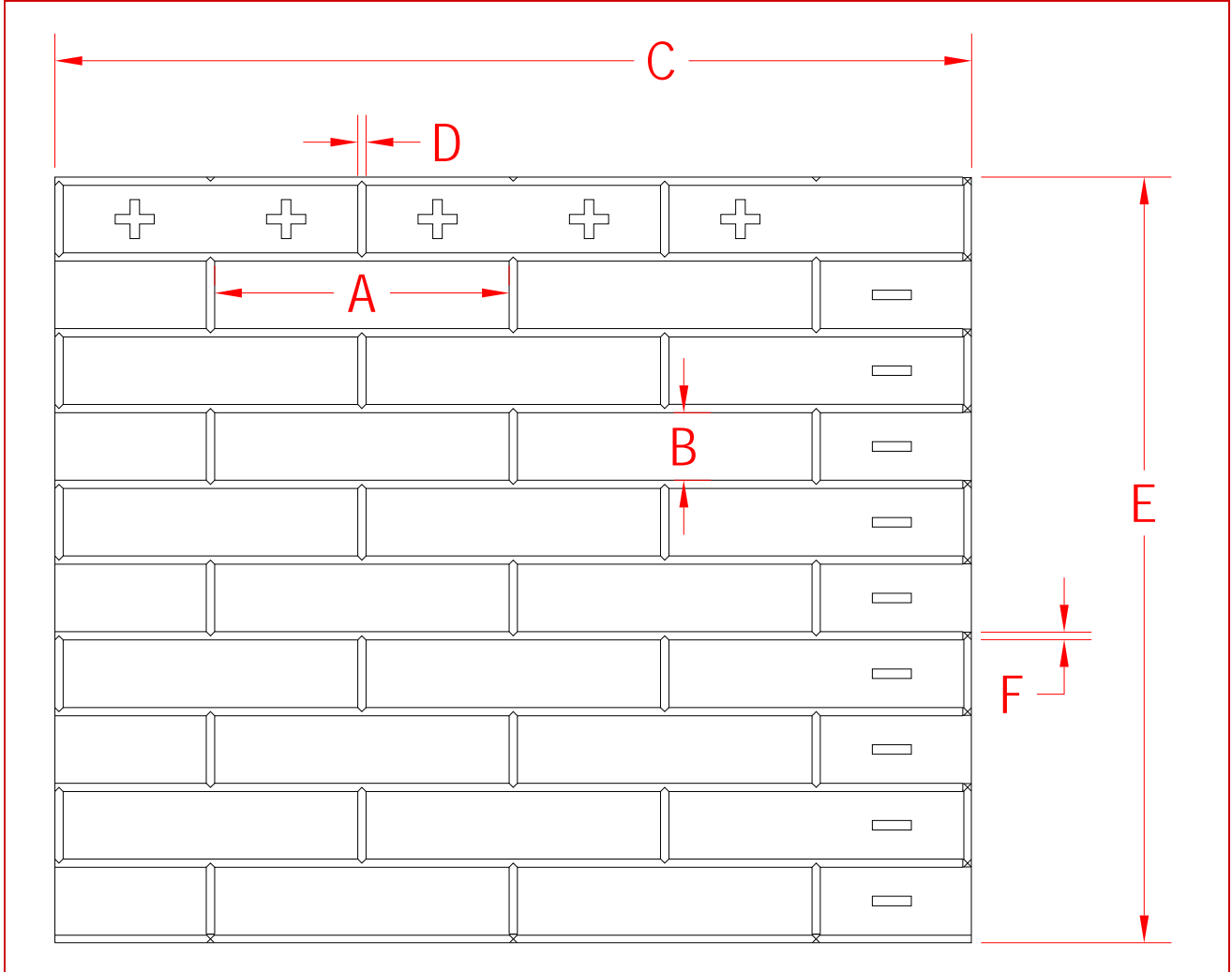

**Coverage / Piece**

Square Feet....	13.33
Linear Feet.....	4

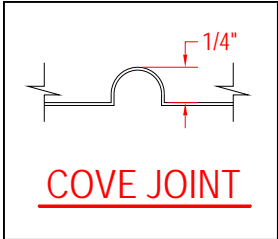

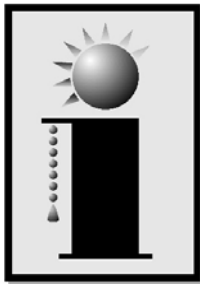

**INNOVATIVE**  
BRICK SYSTEMS, L.L.C.

Innovative Brick Systems, L.L.C.  
11625 Reed Ct.  
Broomfield, Co. 80020  
800-413-4588

**VersaLiner®**  
**#416.1**  
**4x16 1/2 Bond w/False Joint**

**Dimensions**

A... 15 3/8"  
B... 3 9/16"  
C...\* 48"  
D... 13/32"  
E...\* 39 11/16"  
F... 13/32"  
G... 7 27/32"  
H... 3/4"

\* ±1/8" for normal thermal expansion and contraction

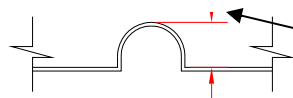
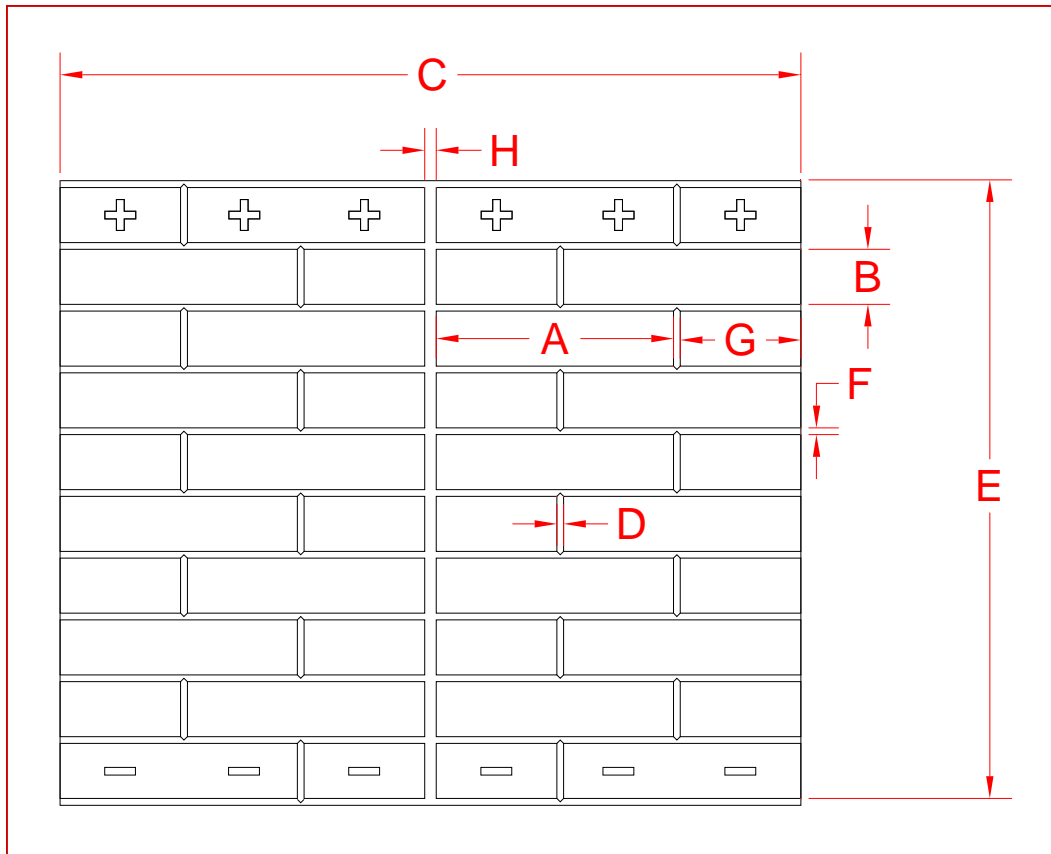

**COVE JOINT**

Joint heights:  
Center joint -- 7/32"  
Head joints and Bed joints -- 3/16"

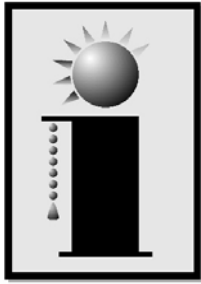

**INNOVATIVE**  
BRICK SYSTEMS, L.L.C.

Innovative Brick Systems, L.L.C.  
11625 Reed Ct.  
Broomfield, Co. 80020  
800-413-4588

**VersaLiner®**  
**#417**  
**4x16 Stacked 1" recess**

**Dimensions**

A... 15 9/16"

B... 3 9/16"

C...\* 16"

D... 7/16"

E...\* 40"

F... .7/16"

\* ±1/8" for normal thermal expansion and contraction

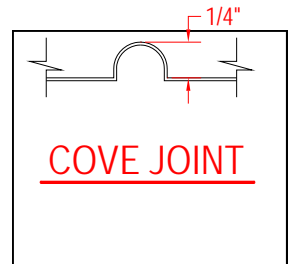
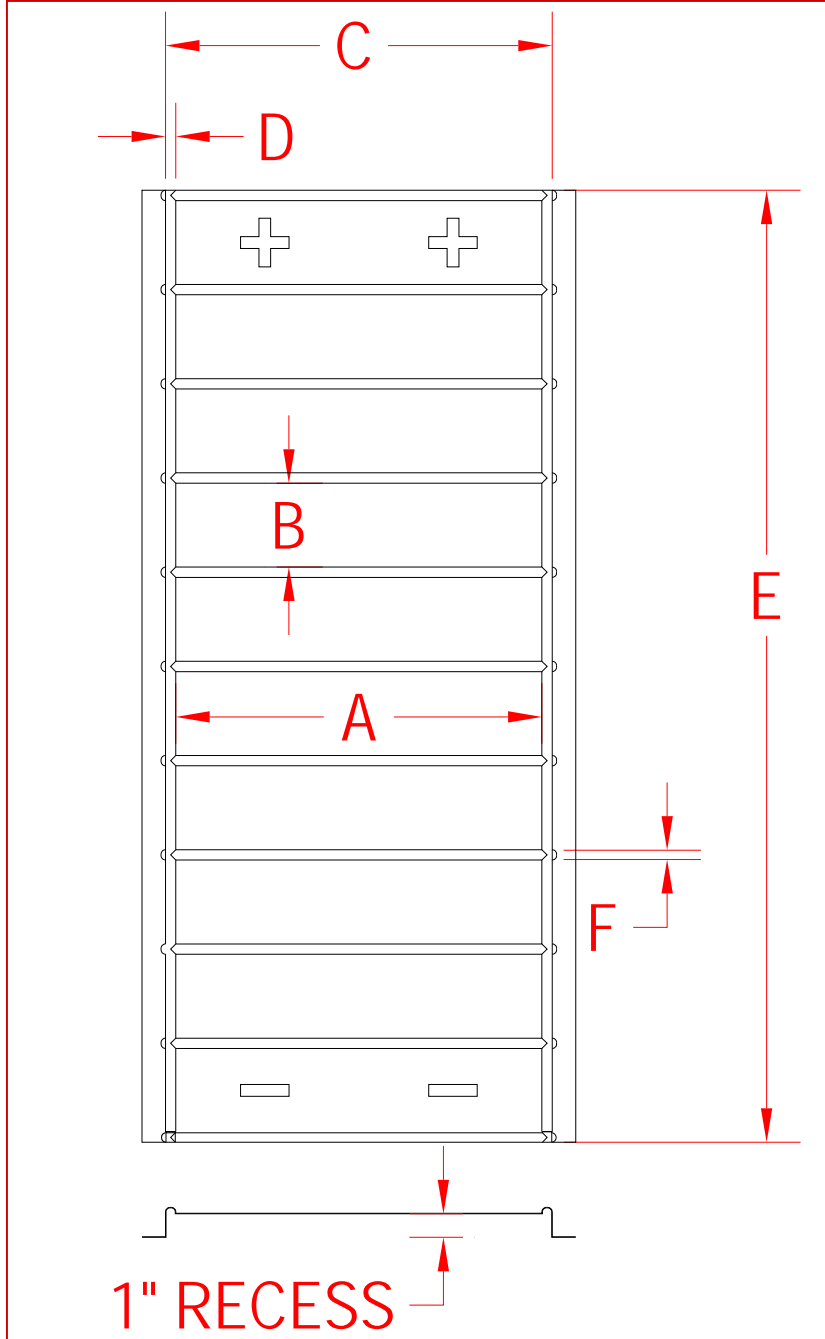

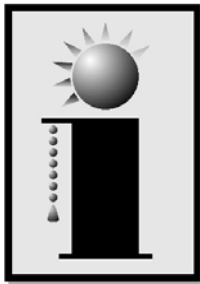

**INNOVATIVE**  
BRICK SYSTEMS, L.L.C.

**Innovative Brick Systems, L.L.C.**  
11625 Reed Ct.  
Broomfield, Co. 80020  
800-413-4588

**VersaLiner®**  
**# SA 201 ARCH COMPONENT**  
**Omega Precast**

**Dimensions**

- A... 2 5/8"
- B... 3"
- C...\* 25.9"
- D... 5/8"
- E...\* 43 1/2"
- F... 3/8"
- G... 3/8"

\* ±1/8" for normal thermal expansion and contraction

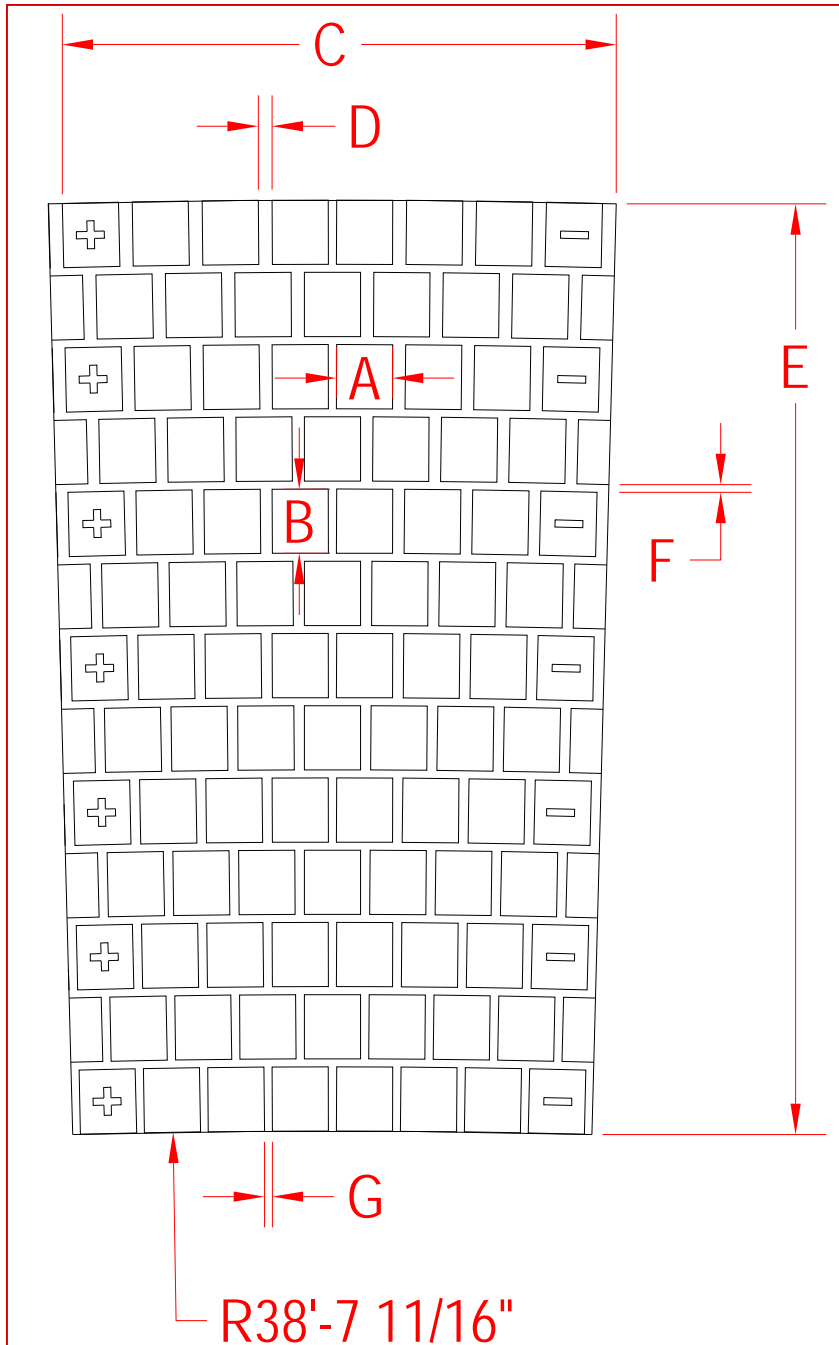

**Coverage / Piece**

Square Feet.... 7.53  
Linear Feet.... 2



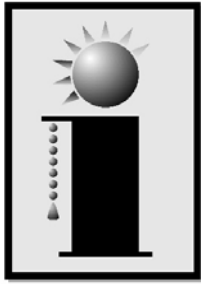

**INNOVATIVE**  
BRICK SYSTEMS, L.L.C.

Innovative Brick Systems, L.L.C.  
11625 Reed Ct.  
Broomfield, Co. 80020  
800-413-4588

## VersaLiner® #SA125 Arch

### Dimensions

A... 7 5/8"  
B... 2 1/4"  
C...\* 44 39/64"  
D... 3/8"  
E...\* 8"  
F... 3/8"

\* ±1/8" for normal thermal  
expansion and contraction

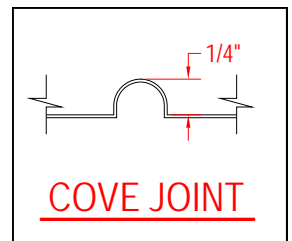
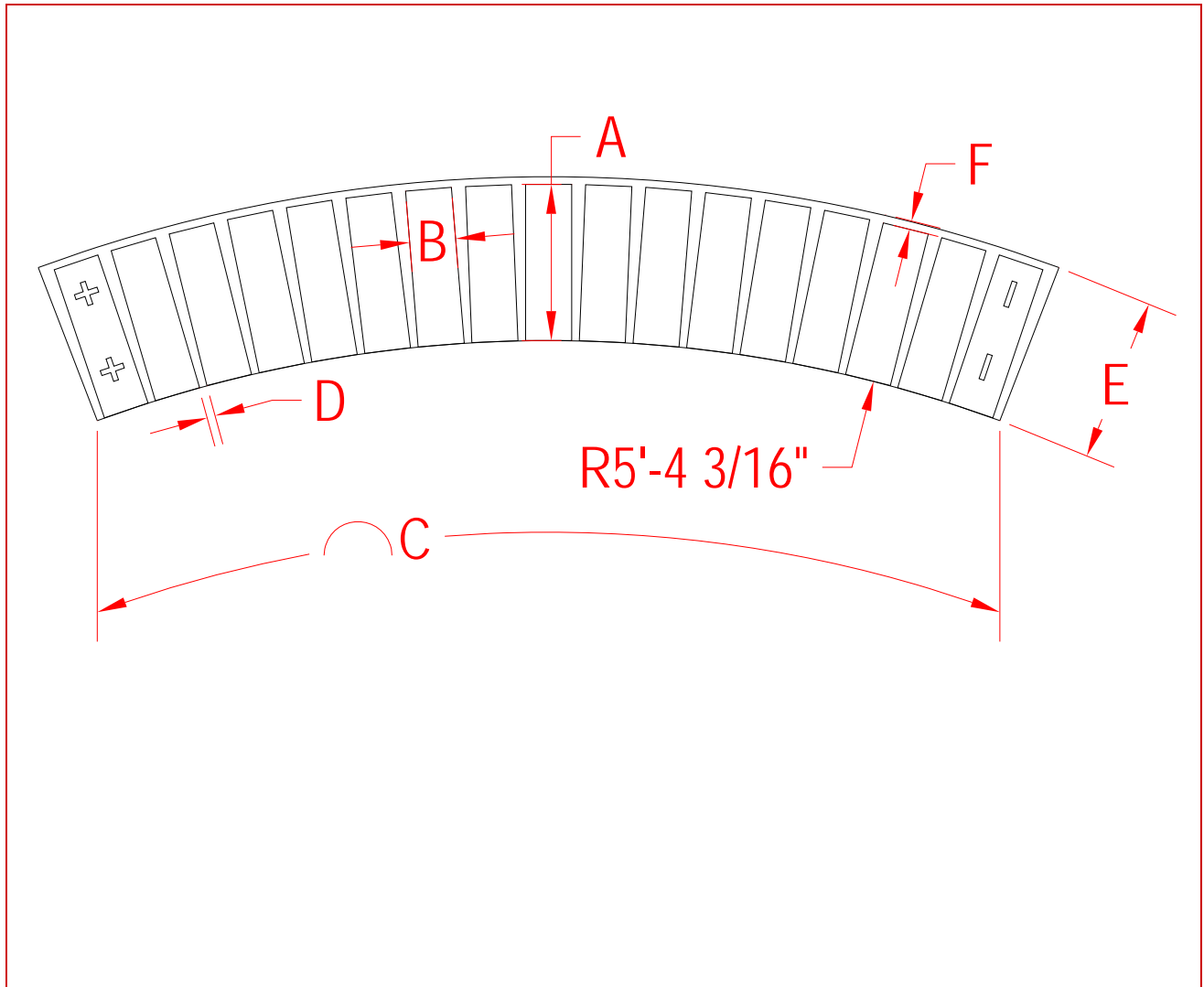

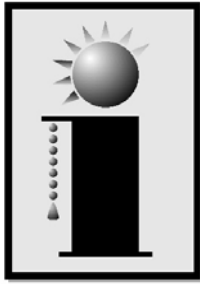

**INNOVATIVE**  
BRICK SYSTEMS, LLC.

Innovative Brick Systems, L.L.C.  
11625 Reed Ct.  
Broomfield, Co. 80020  
800-413-4588

## VersaLiner® #SA 126 Arch

### Dimensions

A... 7 5/8"  
B... 2 1/4"  
C...\* 39 1/4"  
D... .208"  
E...\* 8"  
F... .4166"

\* ±1/8" for normal thermal expansion and contraction

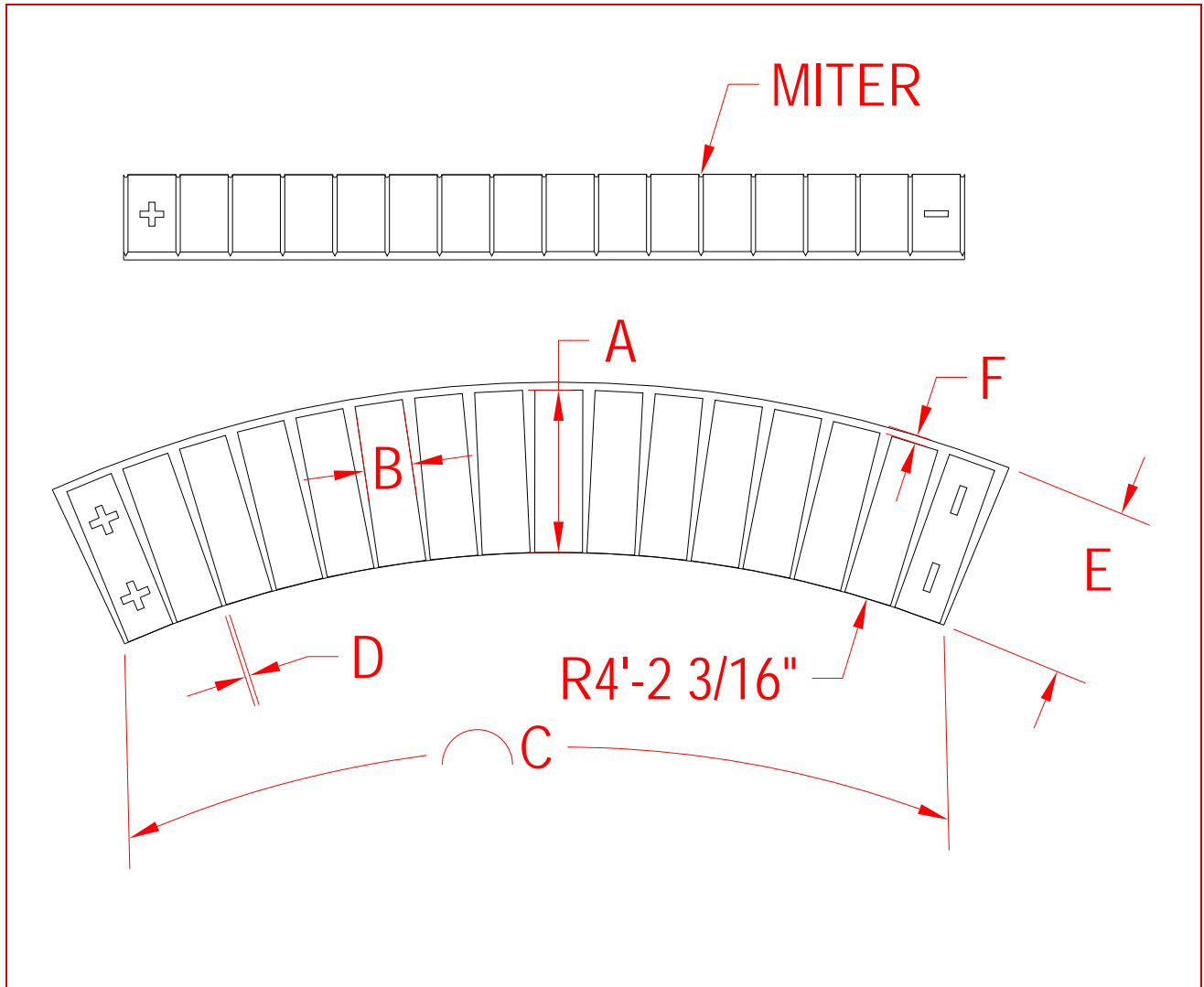

### Coverage / Piece

Linear Feet..... 3.27

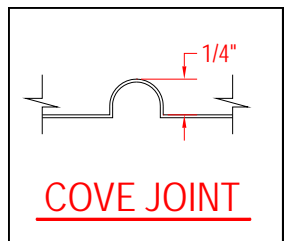

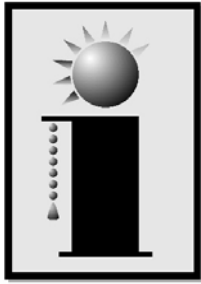

**INNOVATIVE**  
BRICK SYSTEMS, L.L.C.

Innovative Brick Systems, L.L.C.  
11625 Reed Ct.  
Broomfield, Co. 80020  
800-413-4588

**VersaLiner®**  
**#SA 127 Sunburst**  
**w/Flemish Bond Inside**

**Dimensions**

A... 7 5/8"  
B... 2 1/4"  
C...\* 56 3/8"  
D... 3/8"  
E...\* 29 3/4"  
F... .4166"

\* ±1/8" for normal thermal expansion and contraction

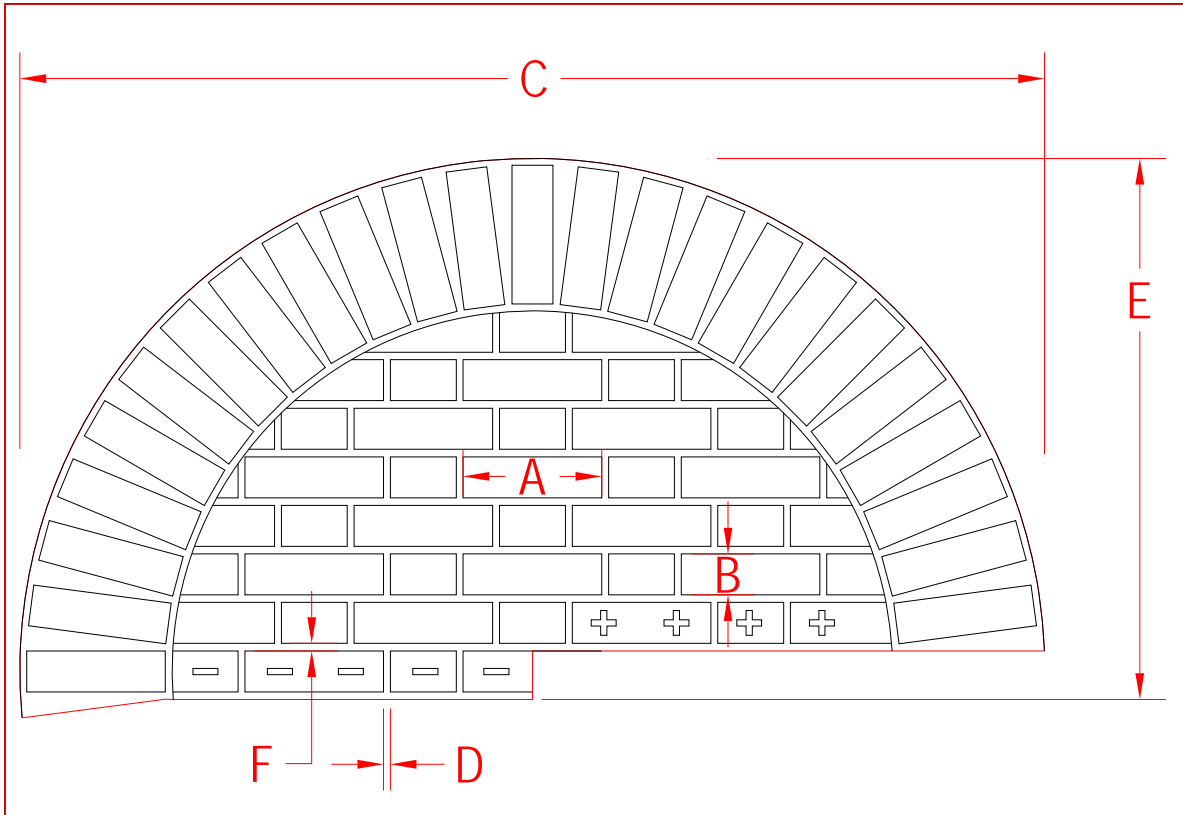

**FINISHED PATTERN**

Two pieces together—Sunburst

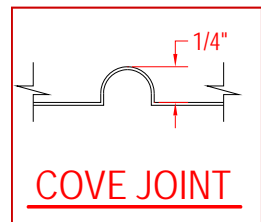
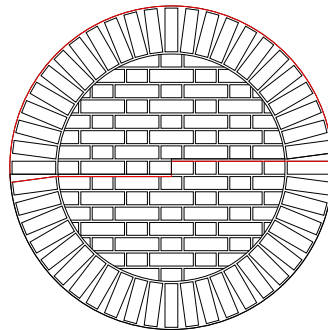
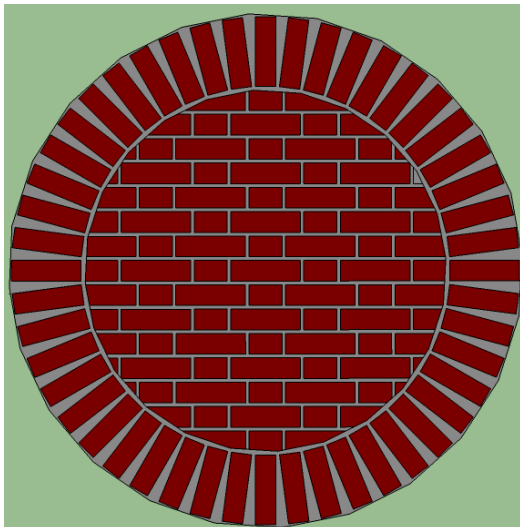

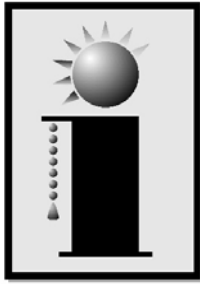

**INNOVATIVE**  
BRICK SYSTEMS, L.L.C.

**Innovative Brick Systems, L.L.C.**  
11625 Reed Ct.  
Broomfield, Co. 80020  
800-413-4588

**VersaLiner®**  
**#SA 128**

**Dimensions**

A... *Varies*  
B... *Varies*  
C...\* 46"  
D... 3/8"  
E...\* 21 7/8"  
F... 3/8"

\* ±1/8" for normal thermal expansion and contraction

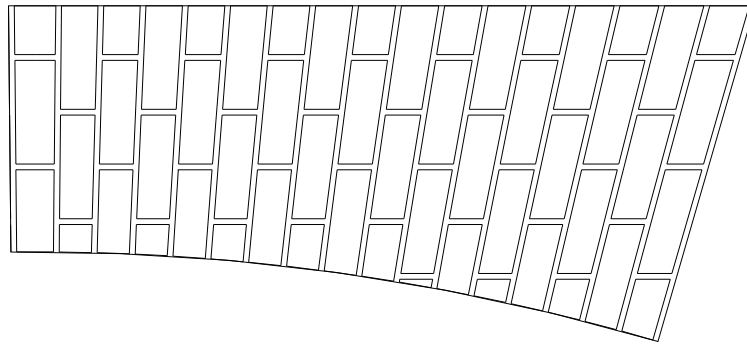
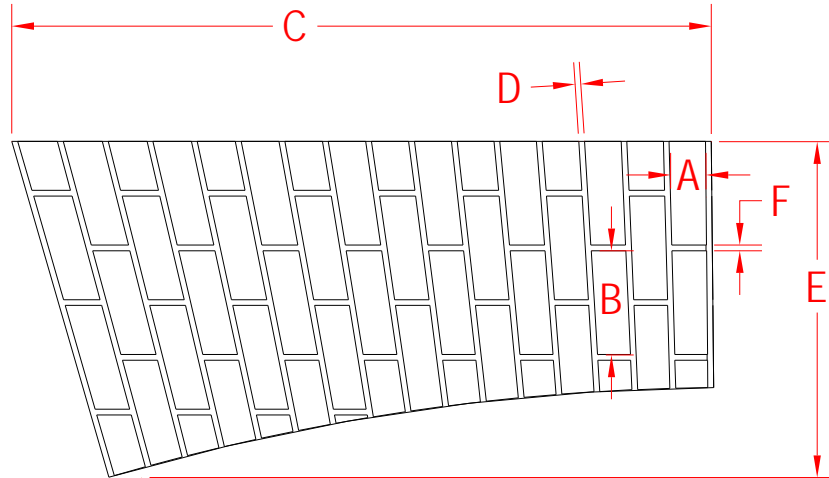

**Coverage / Piece**

*Approximately 12.8 sf*  
*Per complete set*

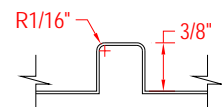

**DEEP RAKE**

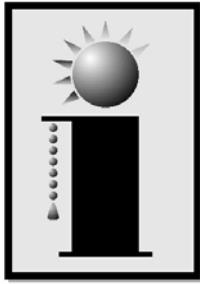

**INNOVATIVE**  
BRICK SYSTEMS, LLC.

**Innovative Brick Systems, L.L.C.**  
11625 Reed Ct.  
Broomfield, Co. 80020  
800-413-4588

**VersaLiner®**  
**#SA 129**  
**Jack Arch**

**Dimensions**

A... *Varies*  
B... *Varies*  
C...\* 37 1/8"  
D... 3/8"  
E...\* 10 5/16"  
F... 3/8"

\* ±1/8" for normal thermal expansion and contraction

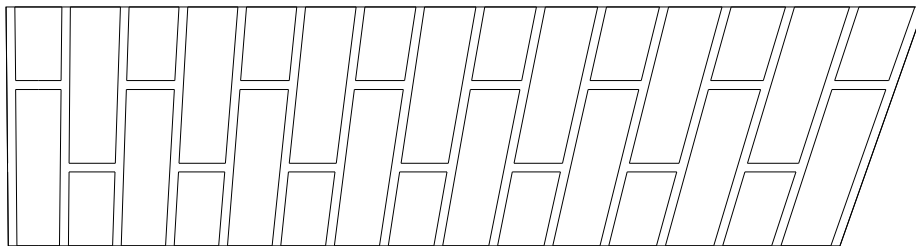
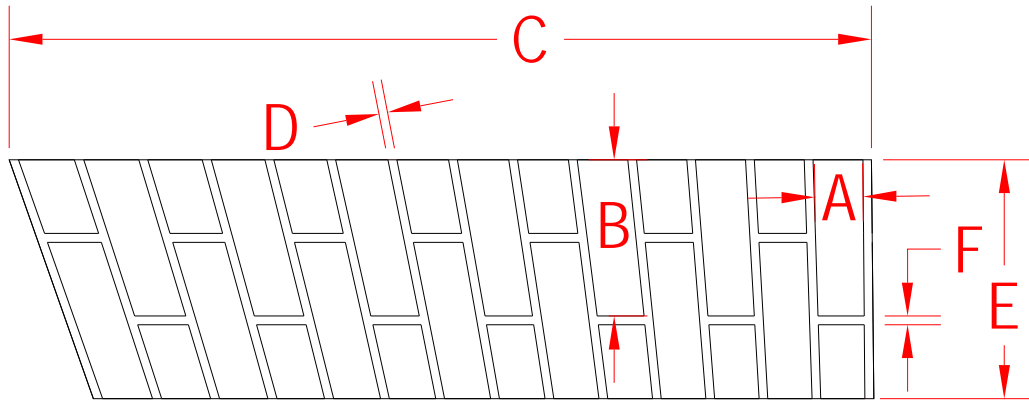

**Coverage / Piece**

*Approximately 5.2 sf*  
*Per complete set*

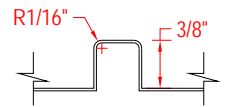

**DEEP RAKE**

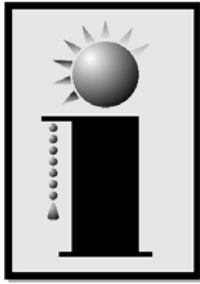

**INNOVATIVE**  
BRICK SYSTEMS, L.L.C.

Innovative Brick Systems, L.L.C.  
11625 Reed Ct.  
Broomfield, Co. 80020  
800-413-4588

**VersaLiner®**  
**#SA 130**

**Dimensions**

A... *Varies*  
B... *Varies*  
C...\* *30 1/2"*  
D... *3/8"*  
E...\* *10 5/16"*  
F... *3/8"*

\* ±1/8" for normal thermal expansion and contraction

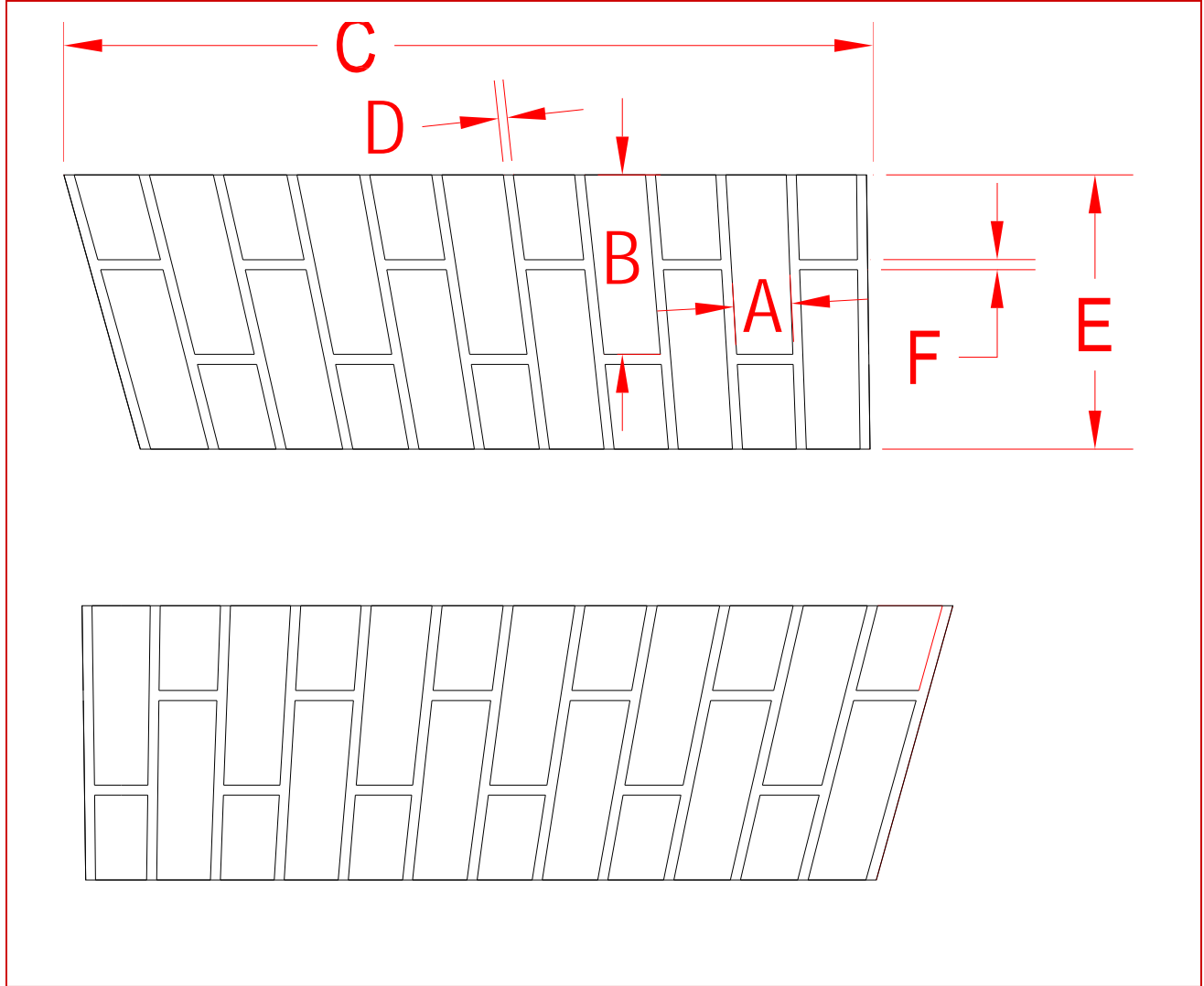

**Coverage / Piece**

*Approximately 4.2 sf*  
*Per complete set*

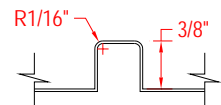

**DEEP RAKE**

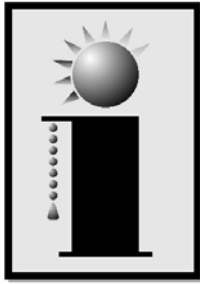

**INNOVATIVE**  
BRICK SYSTEMS, L.L.C.

**Innovative Brick Systems, L.L.C.**  
11625 Reed Ct.  
Broomfield, Co. 80020  
800-413-4588

**VersaLiner®**  
**#SA 131**

**Dimensions**

A... *Varies*  
B... *Varies*  
C...\* *50 15/16"*  
D... *3/8"*  
E...\* *10 5/16"*  
F... *3/8"*

\*  $\pm 1/8"$  for normal thermal expansion and contraction

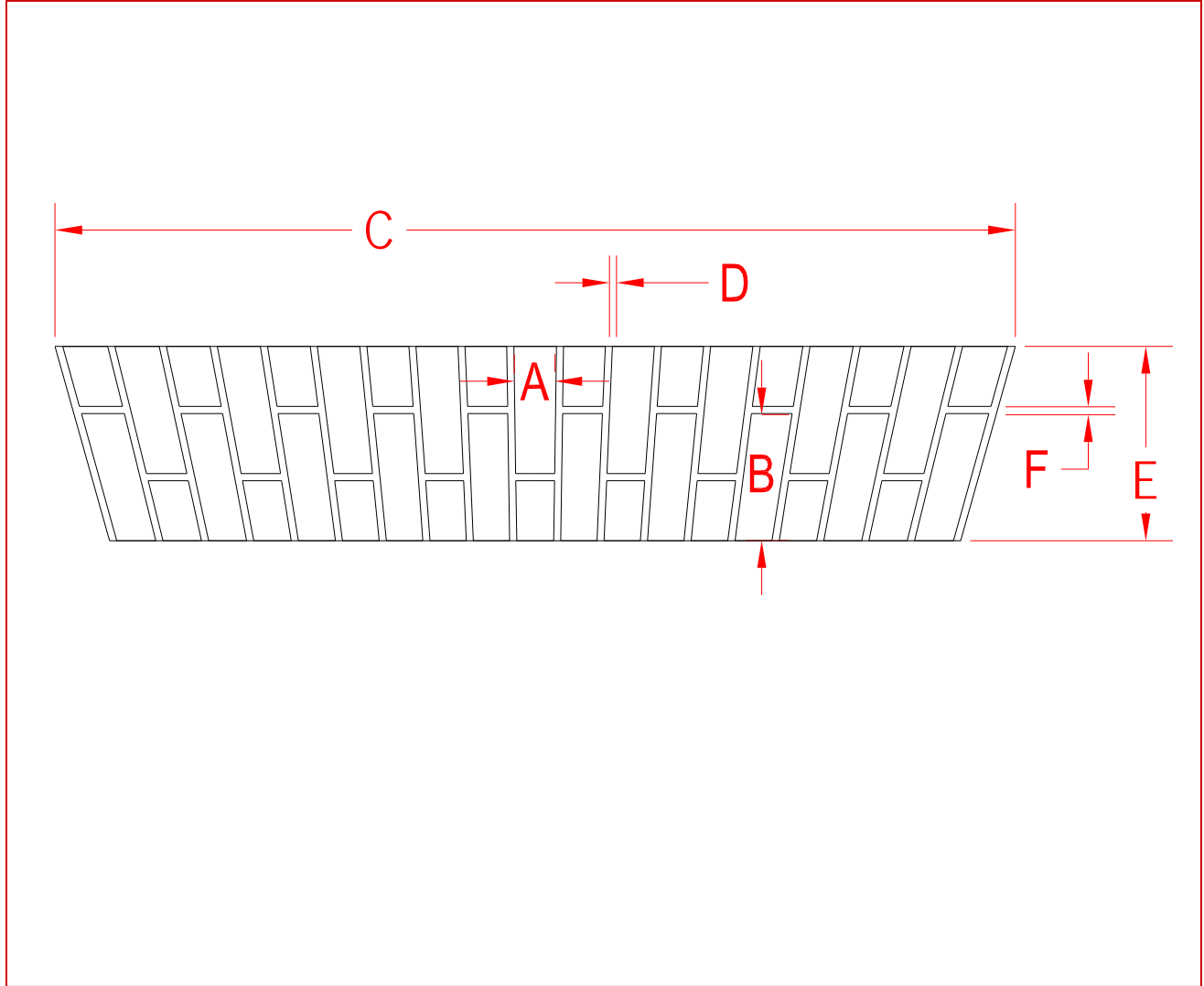

**Coverage / Piece**

*Approximately 3.5 sf*

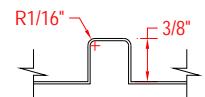

**DEEP RAKE**

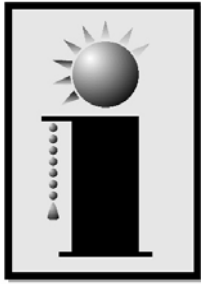

**INNOVATIVE**  
BRICK SYSTEMS, L.L.C.

**Innovative Brick Systems, L.L.C.**  
11625 Reed Ct.  
Broomfield, Co. 80020  
800-413-4588

**VersaLiner®**  
**#SA135**  
**Special Arch**

***Dimensions***

A... 7 5/8"  
B... 3 5/8"  
C...\* 31 11/16"  
D... .393"  
E...\* 15 5/8"  
F... 3/8"

\* ±1/8" for normal thermal expansion and contraction

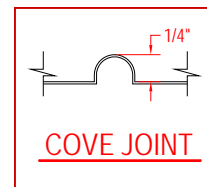
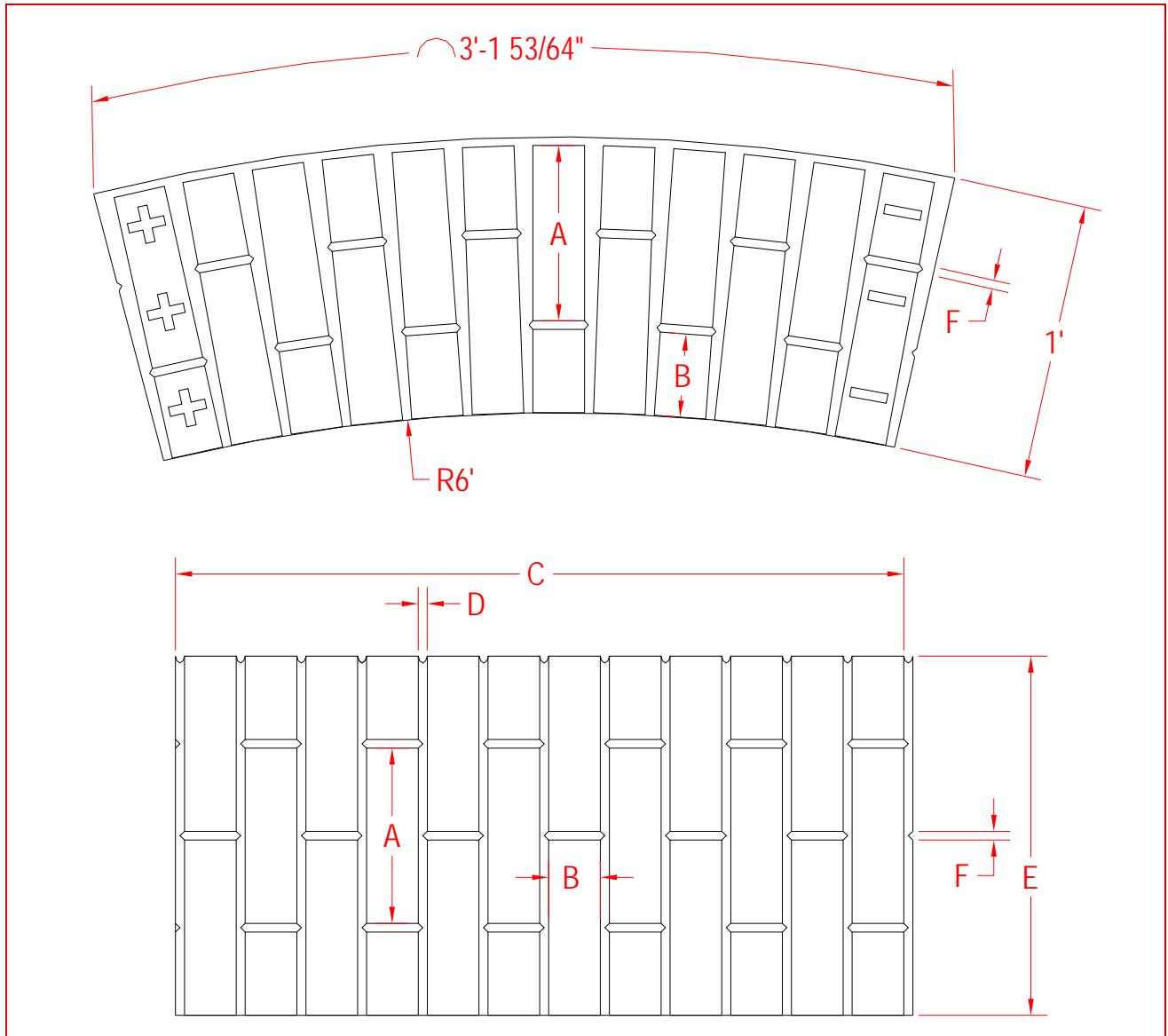

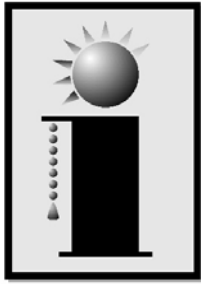

**INNOVATIVE**  
BRICK SYSTEMS, L.L.C.

**Innovative Brick Systems, L.L.C.**  
11625 Reed Ct.  
Broomfield, Co. 80020  
800-413-4588

**VersaLiner®**  
**#SA136**  
**Special Arch**

**Dimensions**

A... 7 3/8"  
B... 3 5/8"  
C...\* 32 1/8"  
D... .431"  
E...\* 3 3/8"  
F... 3/8"

\* ±1/8" for normal thermal expansion and contraction

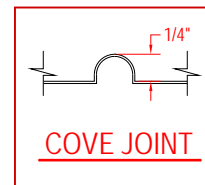
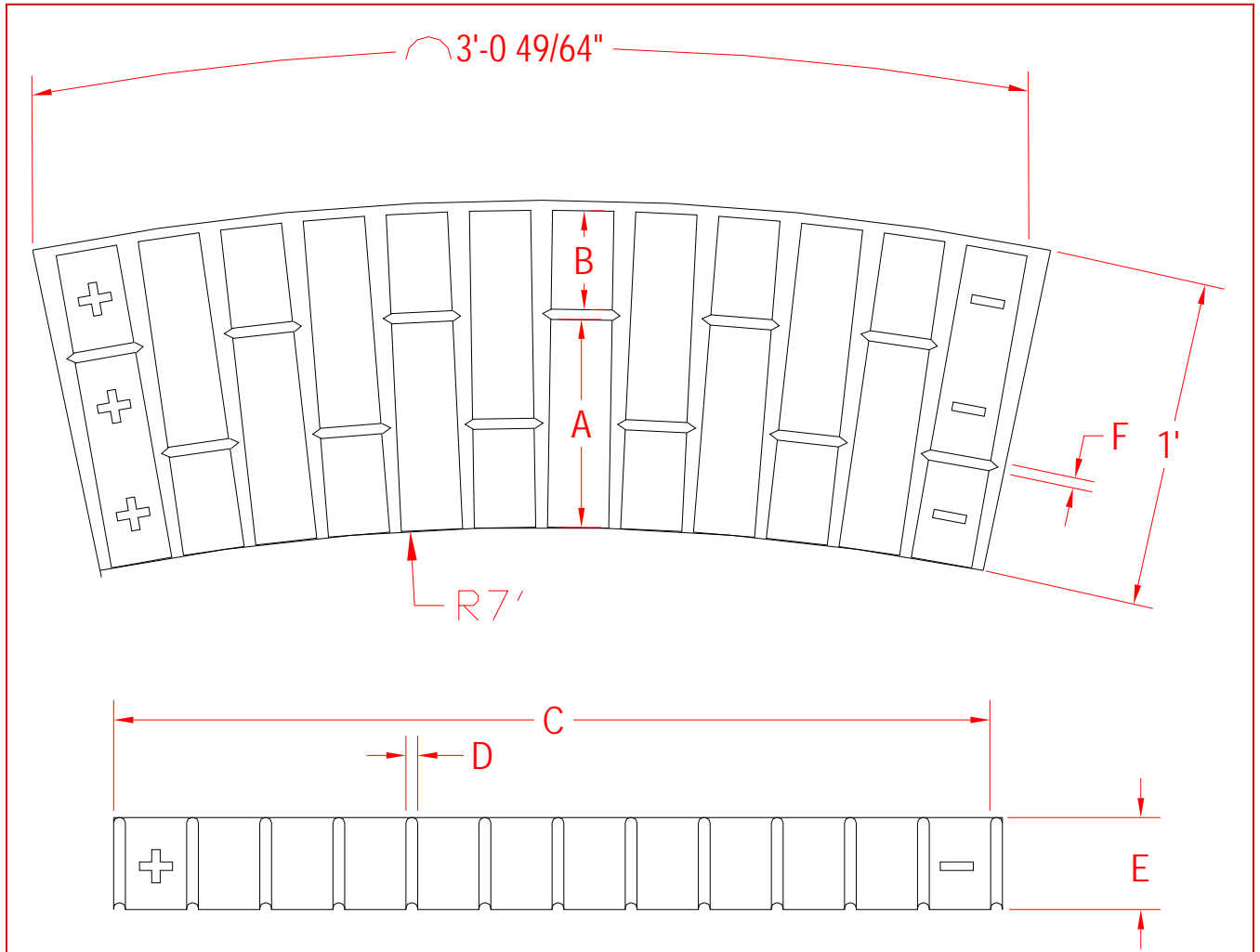

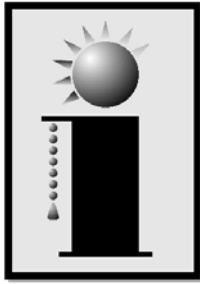

**INNOVATIVE**  
BRICK SYSTEMS, L.L.C.

Innovative Brick Systems, L.L.C.  
11625 Reed Ct.  
Broomfield, Co. 80020  
800-413-4588

**VersaLiner®**  
**#SA137a**  
**Special Arch (used with 137b)**

***Dimensions***

A... 3 5/8"  
B... 7 5/8"  
C...\* 31 5/8"  
D... .408"  
E...\* 3 3/8"  
F... 3/8"

\* ±1/8" for normal thermal expansion and contraction

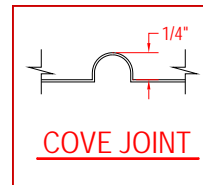
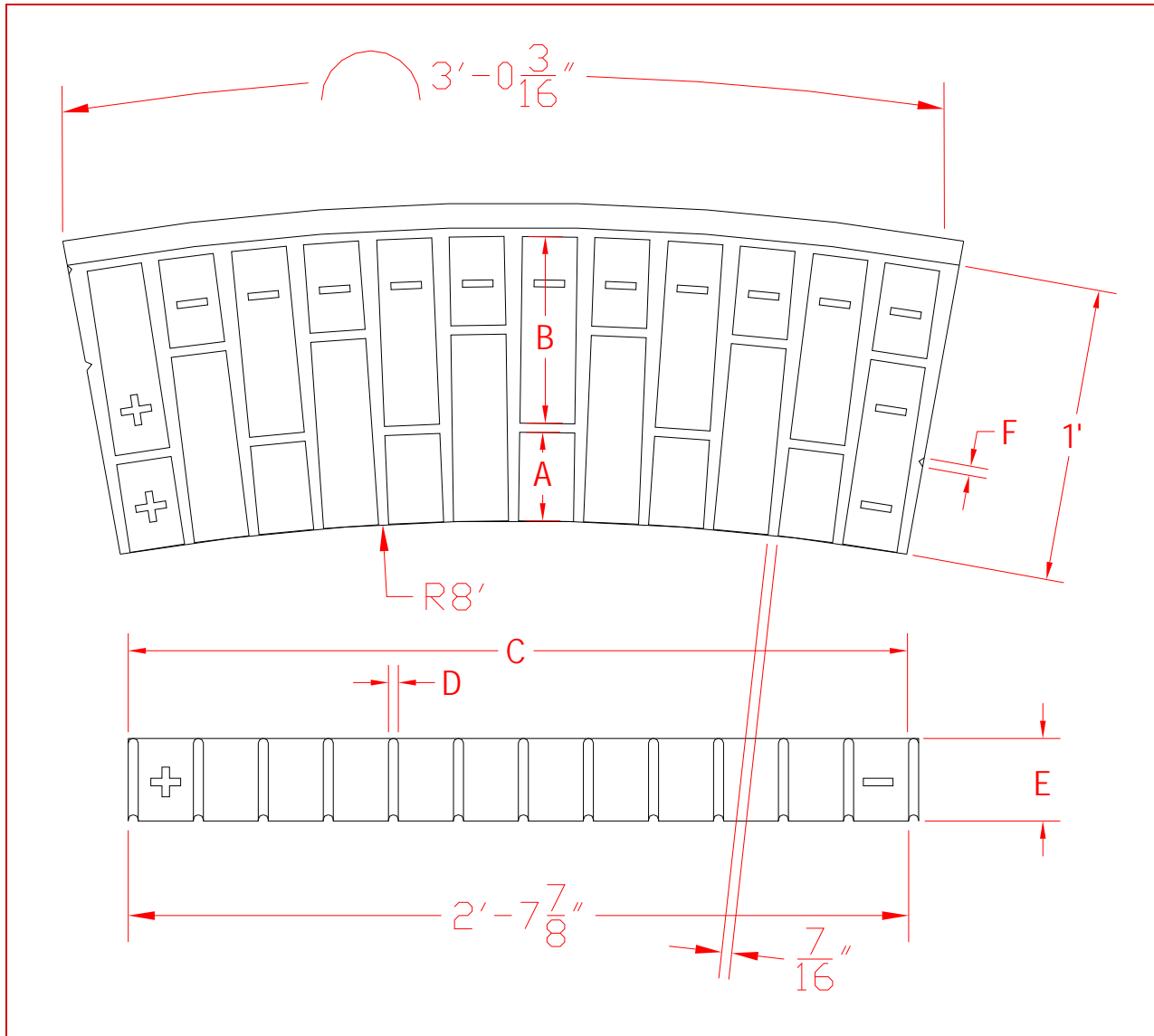

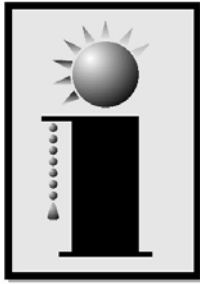

**INNOVATIVE**  
BRICK SYSTEMS, L.L.C.

Innovative Brick Systems, L.L.C.  
11625 Reed Ct.  
Broomfield, Co. 80020  
800-413-4588

**VersaLiner®**  
**#SA137b**  
**Special Arch (used with 137a)**

***Dimensions***

A... 3 5/8"  
B... 7 5/8"  
C...\* 35 3/16"  
D... .437"  
E...\* 12"  
F... 3/8"

\* ±1/8" for normal thermal expansion and contraction

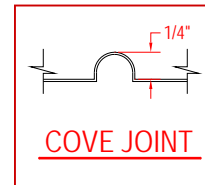
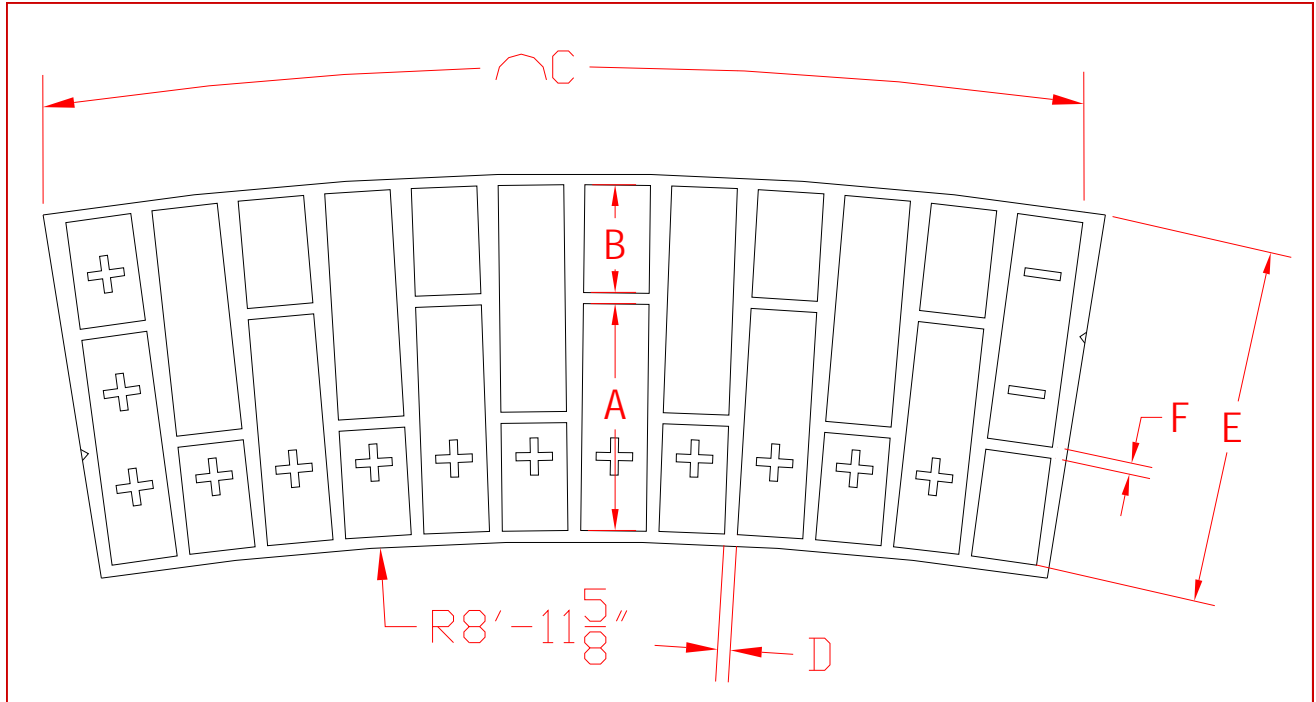

COVE JOINT



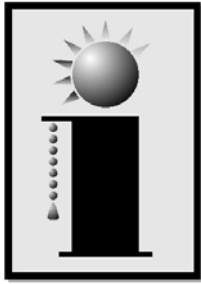

**INNOVATIVE**  
BRICK SYSTEMS, L.L.C.

**Innovative Brick Systems, L.L.C.**  
11625 Reed Ct.  
Broomfield, Co. 80020  
800-413-4588

**VersaLiner®**  
**4100**  
**Metric 1/2 Bond**

**Dimensions**

A... 215mm  
B... 65mm  
C...\* 600mm  
D... 10mm  
E...\* 900mm  
F... 10mm

\* ±13mm for normal thermal expansion and contraction

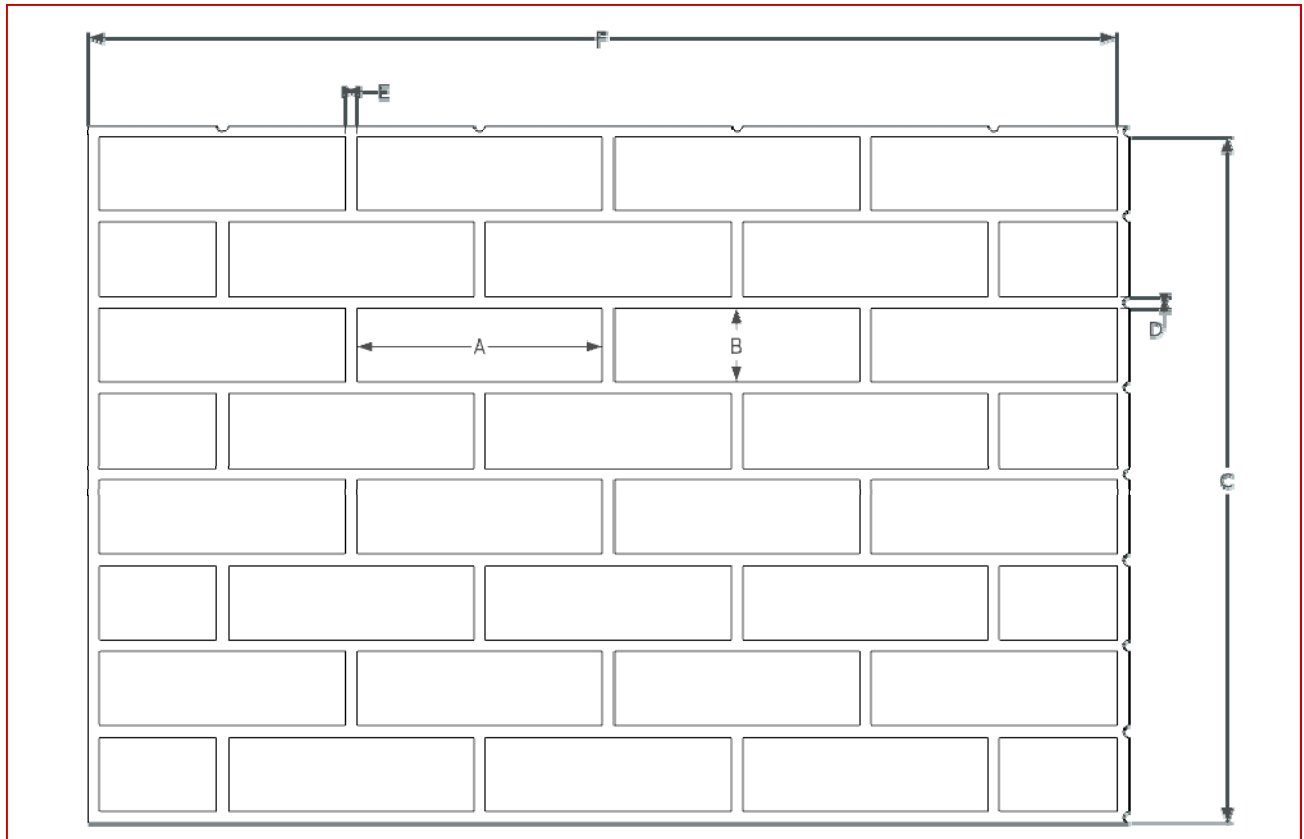

**Cove Joint**

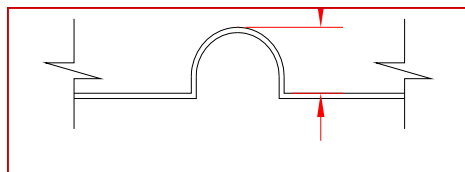

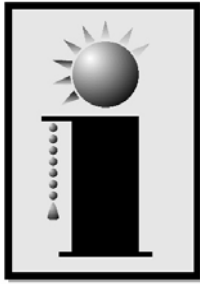

**INNOVATIVE**  
BRICK SYSTEMS, L.L.C.

Innovative Brick Systems, L.L.C.  
11625 Reed Ct.  
Broomfield, Co. 80020  
800-413-4588

## VersaLiner® 4120

### Dimensions

A... 215mm  
B... 65mm  
C...\* 225mm  
D... 10mm  
E...\* 900mm  
F... 10mm

\* ±13mm for normal thermal  
expansion and contraction

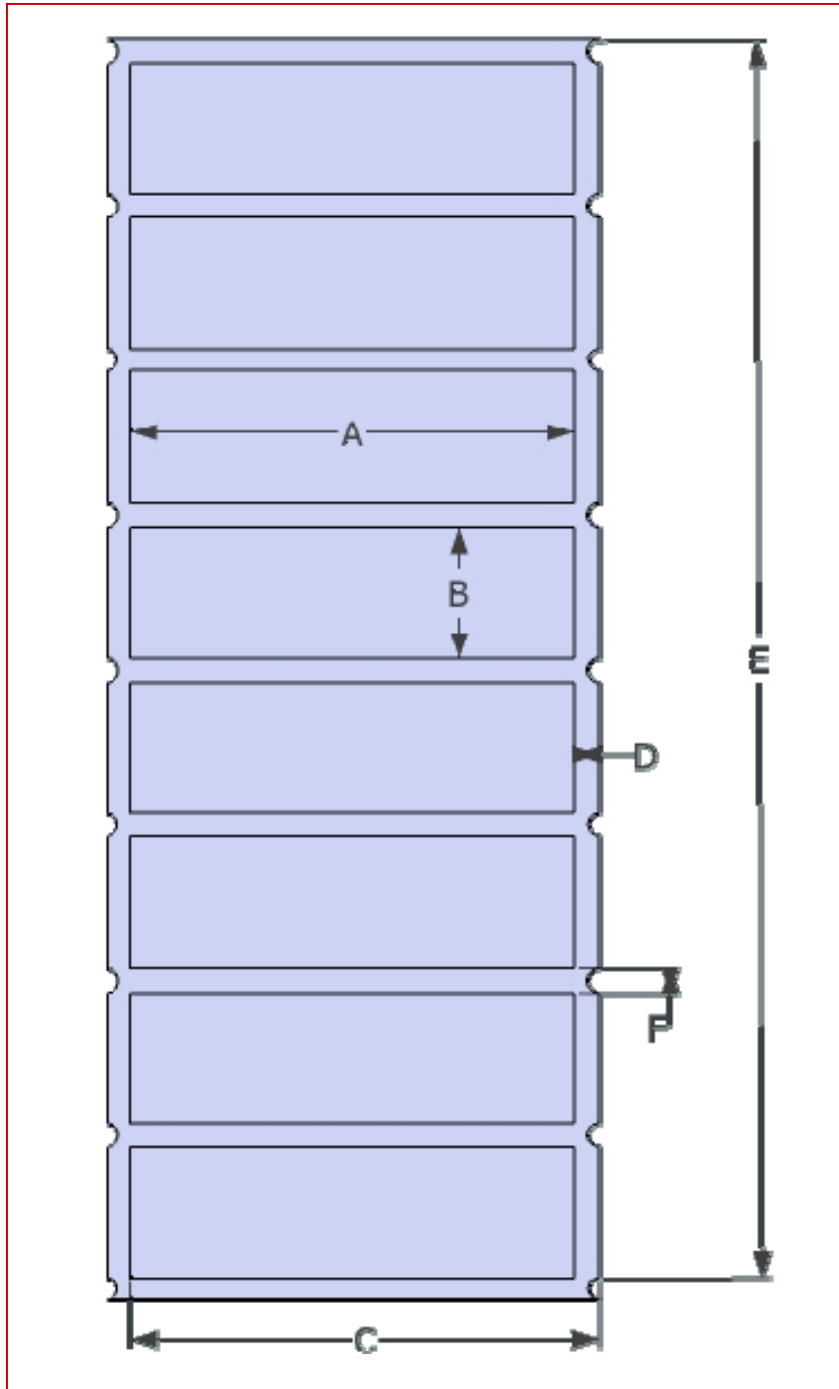

### Cove Joint

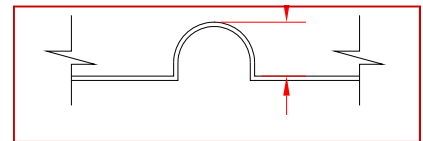

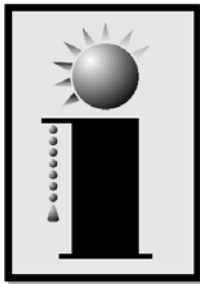

**INNOVATIVE**  
BRICK SYSTEMS, L.L.C.

Innovative Brick Systems, L.L.C.  
11625 Reed Ct.  
Broomfield, Co. 80020  
800-413-4588

## VersaLiner® 4125

### Dimensions

A... 215mm  
B... 65mm  
C...\* 225mm  
D... 10mm  
E...\* 900mm  
F... 10mm

\* ±13mm for normal thermal  
expansion and contraction

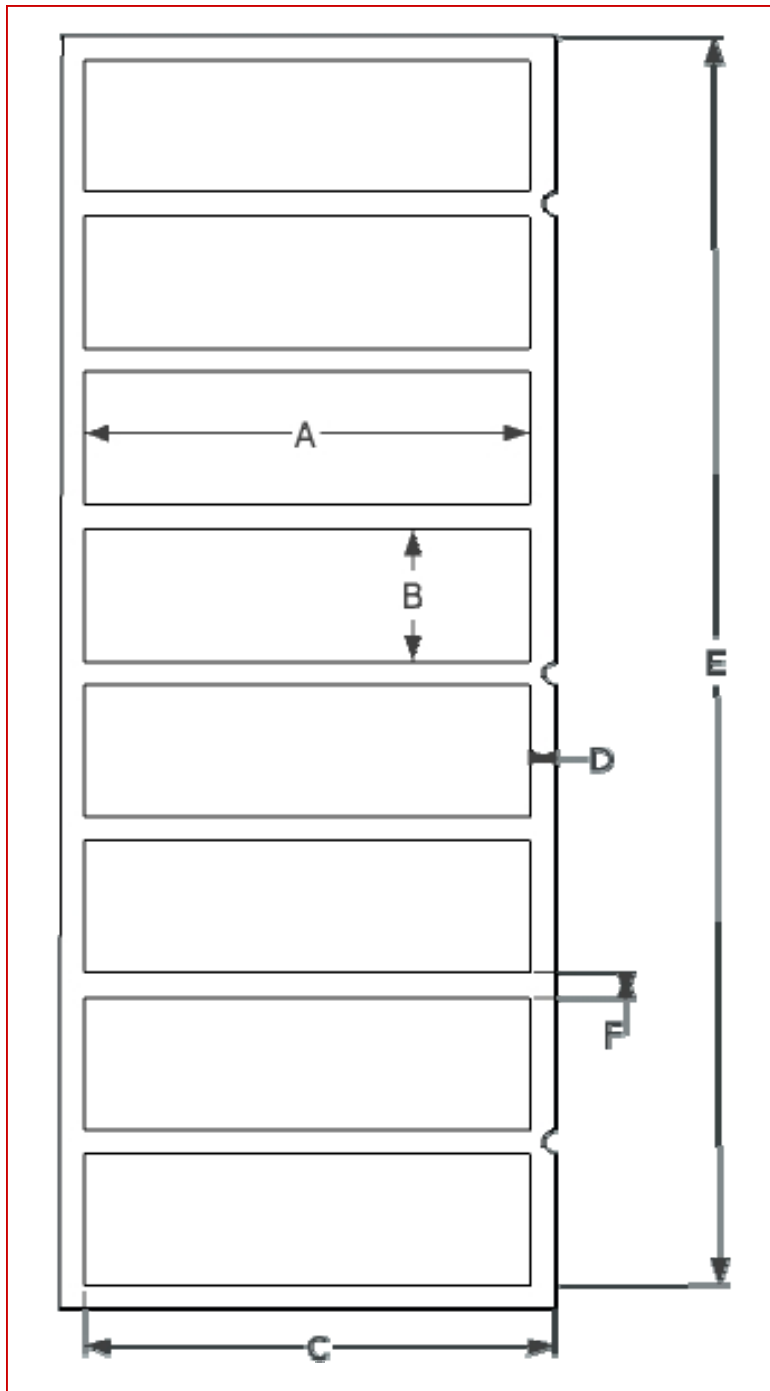

### Cove Joint

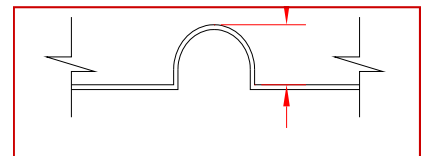

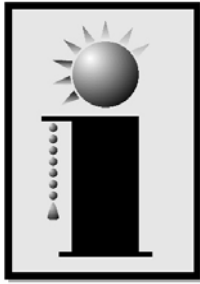

**INNOVATIVE**  
BRICK SYSTEMS, LLC.

Innovative Brick Systems, L.L.C.  
11625 Reed Ct.  
Broomfield, Co. 80020  
800-413-4588



## VersaLiner® #903 Edge Strip 3/8"

Patent Number: US 6929234

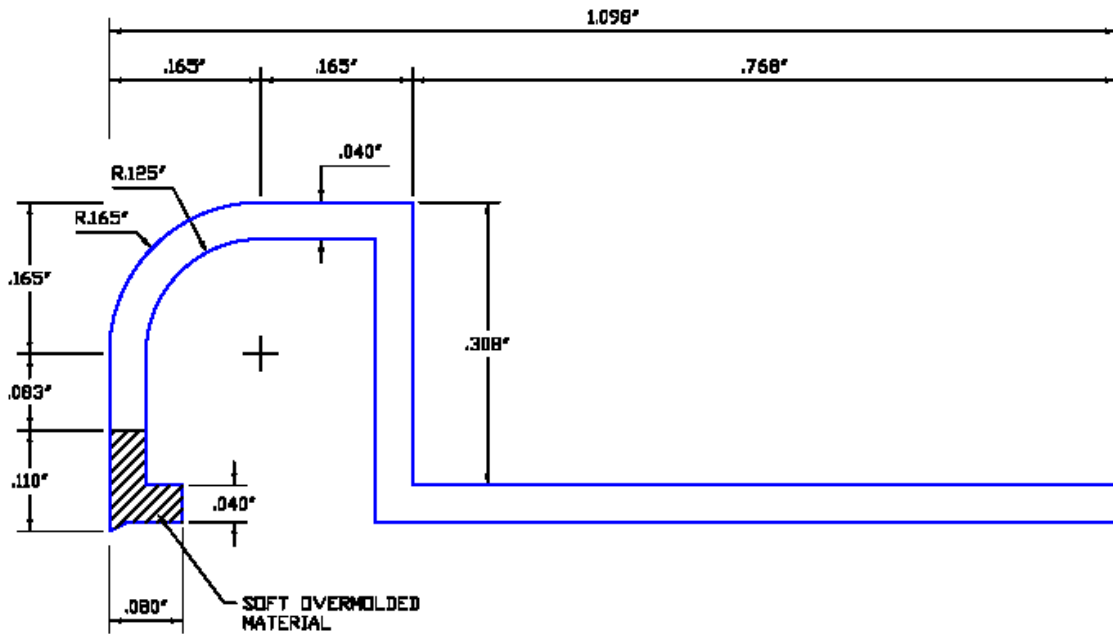



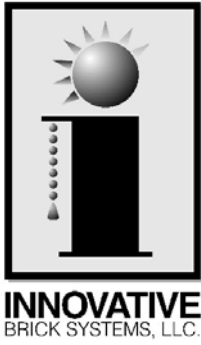

**Innovative Brick Systems, L.L.C.**  
11625 Reed Ct.  
Broomfield, Co. 80020  
800-413-4588

**Dimensions**  
A...  
B...  
C...\* 24+ "  
D...  
E...\* 8+ "  
F...  
  
\* ±1/8" for normal thermal expansion and contraction

**VersaLiner®**  
**#199 Brick Gauge CFTJ\***

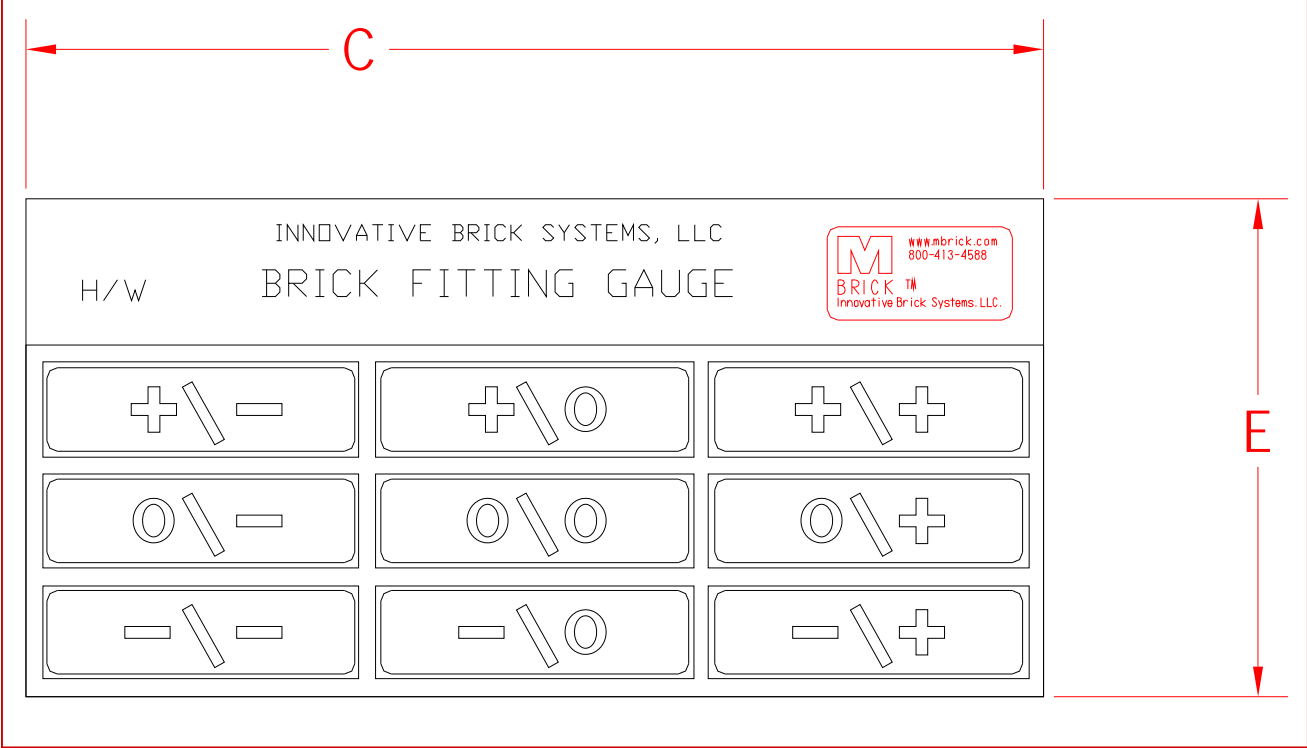

The purpose of the “brick gauge” is to match the brick with the best pocket size possible for a tight fit while allowing the liner to accommodate the widest variation in brick sizing. The “+” indicates an oversized dimension and the “-” indicates an undersized dimension. Height on left \ width on the right (long side).

**\* CFTJ—joint is “compression fit” joint.**

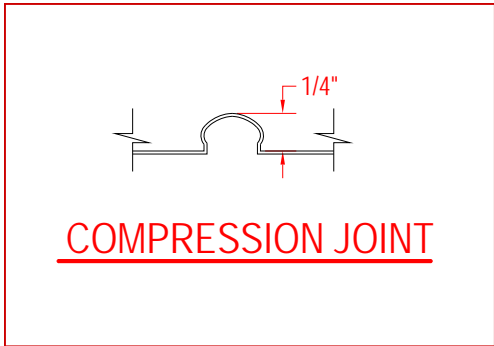

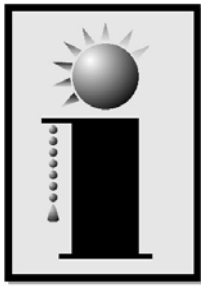

**INNOVATIVE**  
BRICK SYSTEMS, L.L.C.

**Innovative Brick Systems, L.L.C.**  
11625 Reed Ct.  
Broomfield, Co. 80020  
800-413-4588

## VersaLiner® Joint Options

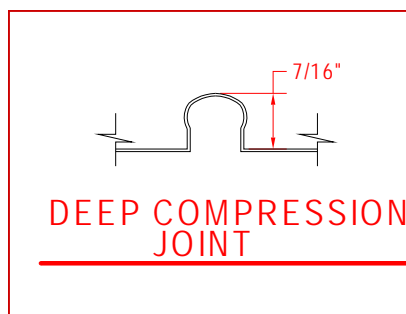
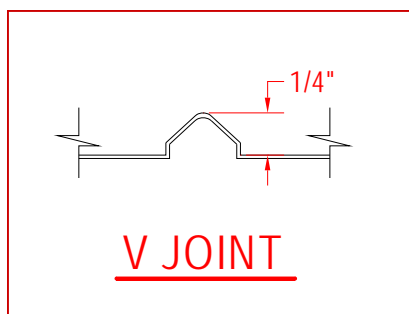
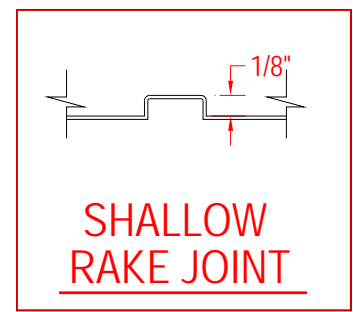
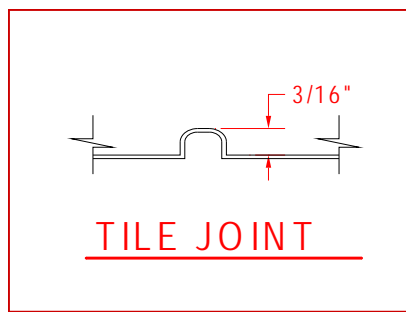
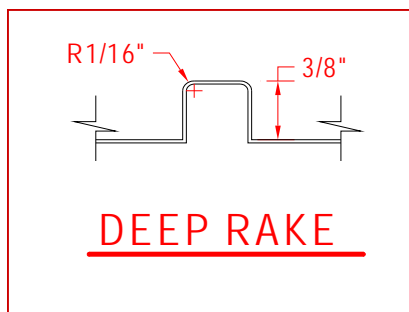
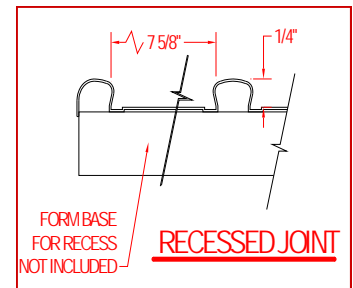
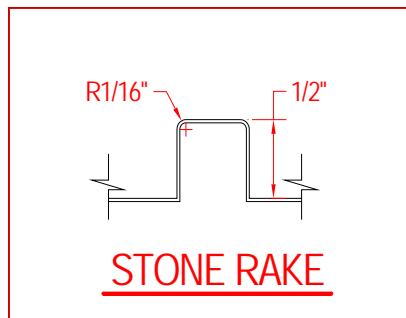
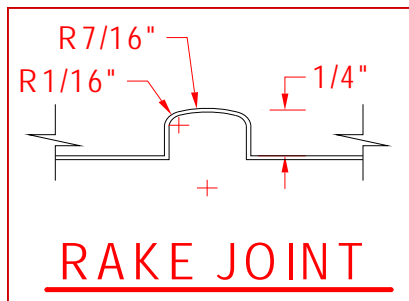
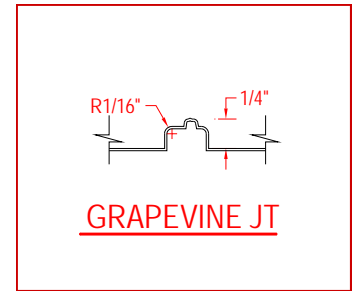
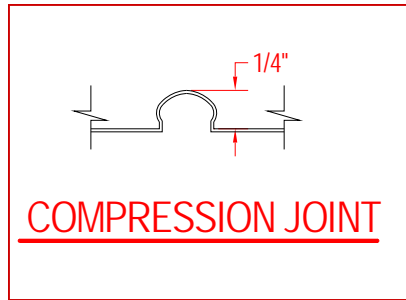
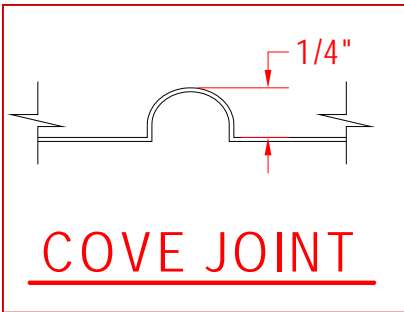

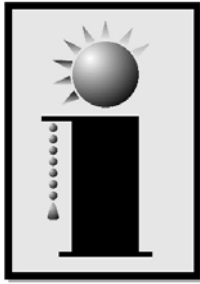

**INNOVATIVE**  
BRICK SYSTEMS, L.L.C.

**Innovative Brick Systems, L.L.C.**  
11625 Reed Ct.  
Broomfield, Co. 80020  
800-413-4588



## VersaLiner® Your Design

**Make your own design and send to  
us for a quote!**

### Brick Size

- Modular 2 1/4" x 7 5/8"
- Closure 3 5/8" x 7 5/8"
- Norman 2 1/4" x 11 5/8"
- Utility 3 5/8" x 11 5/8"
- Other \_\_\_\_\_

### Bond Pattern

- Running Bond (1/2)
- 1/3 Bond
- Flemish
- Soldier
  - Aligned
  - Offset
  - # rows \_\_\_\_\_
- Stack Bond
  - # rows \_\_\_\_\_
- Row lock
- Header (1/2 stretcher)
- Single Stretcher
- Herringbone
- Basketweave
- Other (see drawing)

### Joint Design

- Basic Cove
- Compression Joint
- Deep Compression Joint
- "V" Joint
- Rake Joint
- Deep Rake
- Shallow Rake
- Grapevine
- Stone Rake
  
- Recess \_\_\_\_\_
- Joint Special Dim.
  - Bed \_\_\_\_\_
  - Head \_\_\_\_\_

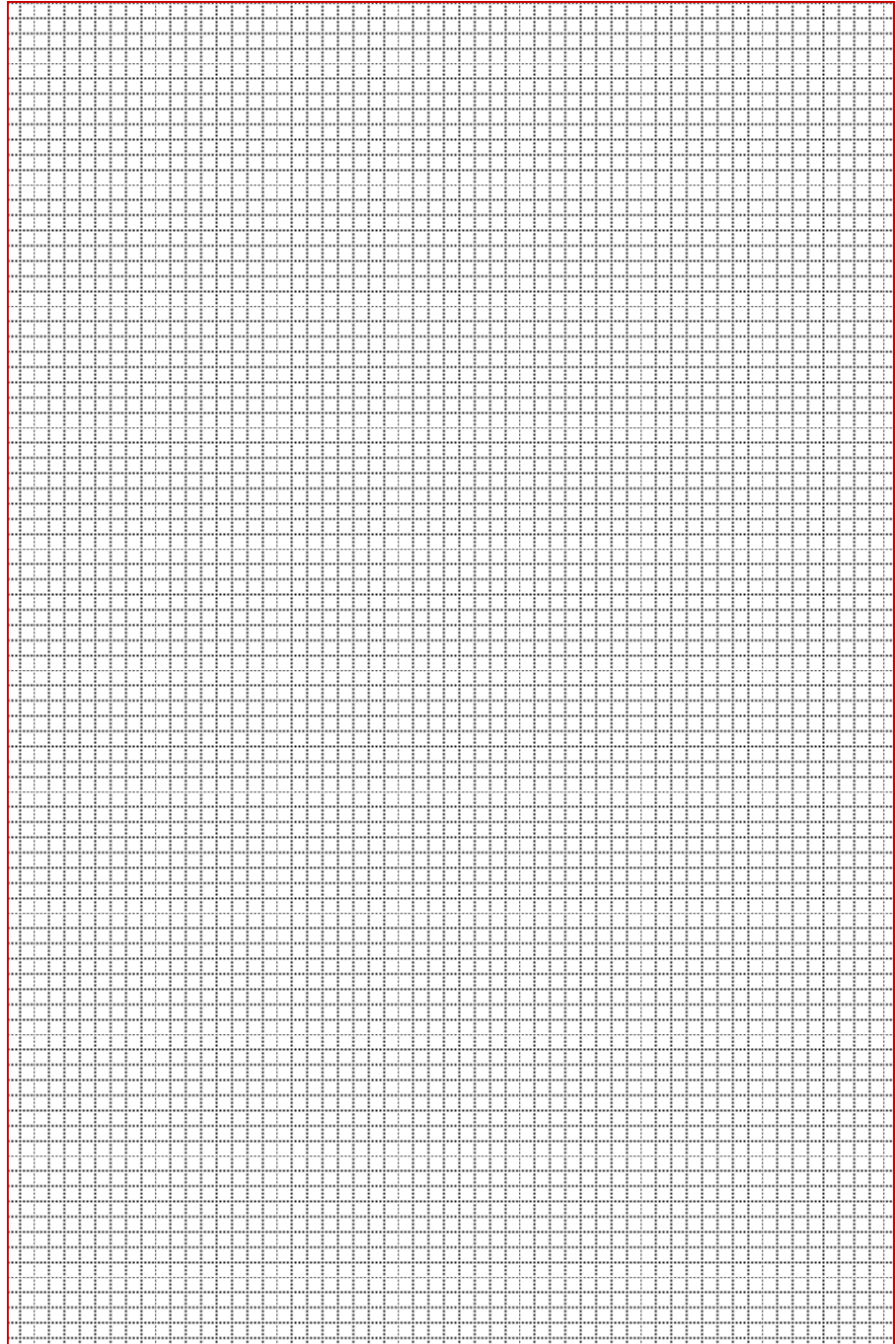

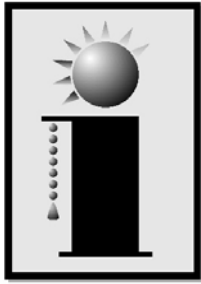

**INNOVATIVE**  
BRICK SYSTEMS, L.L.C.

Innovative Brick Systems, L.L.C.  
11625 Reed Ct.  
Broomfield, Co. 80020  
800-413-4588

**Dimensions**

A... 8"  
B... 2.5"  
C...\* 42 1/2"  
D... 1/2"  
E...\* 36 "  
F... 1/2"

\* ±1/8" for normal thermal expansion and contraction

**VersaLiner®**  
**#S 258 Special 2 1/2 x 8**  
**Running Bond w/ 1/2" Rake Joint**

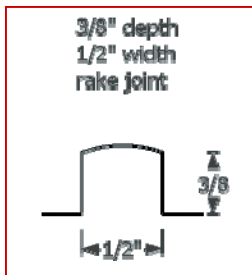
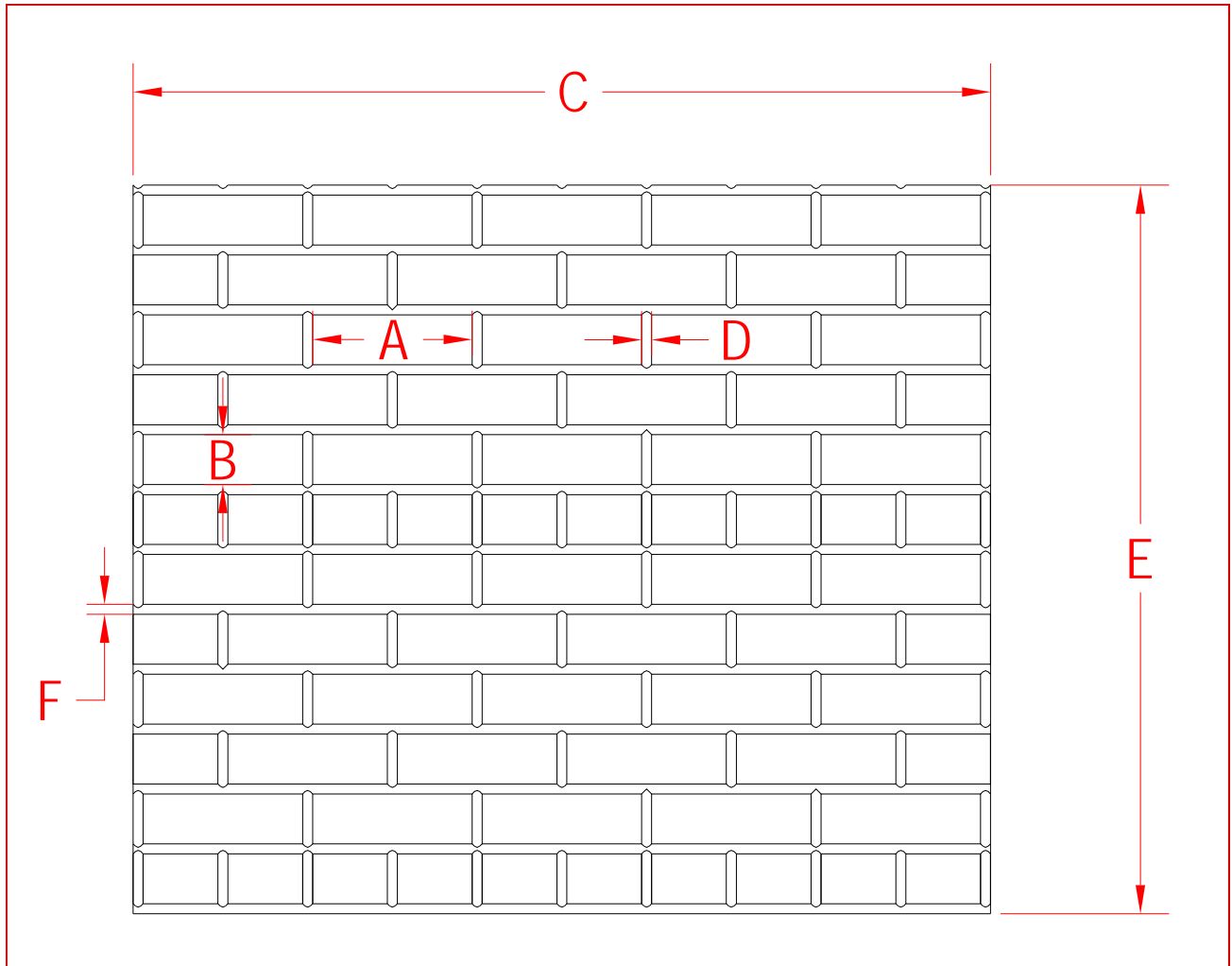

**Coverage / Piece**

Square Feet.... 10.63  
Linear Feet..... 3.54



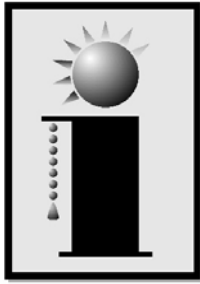

**INNOVATIVE**  
BRICK SYSTEMS, L.L.C.

Innovative Brick Systems, L.L.C.  
11625 Reed Ct.  
Broomfield, Co. 80020  
800-413-4588

**VersaLiner®**  
**#862**  
**8x8 Running Bond**

**Dimensions**

- A... 7 5/8"
- B... 7 5/8"
- C...\* 44"
- D... 3/8"
- E...\* 48 "
- F... 3/8"

\* ±1/8" for normal thermal expansion and contraction

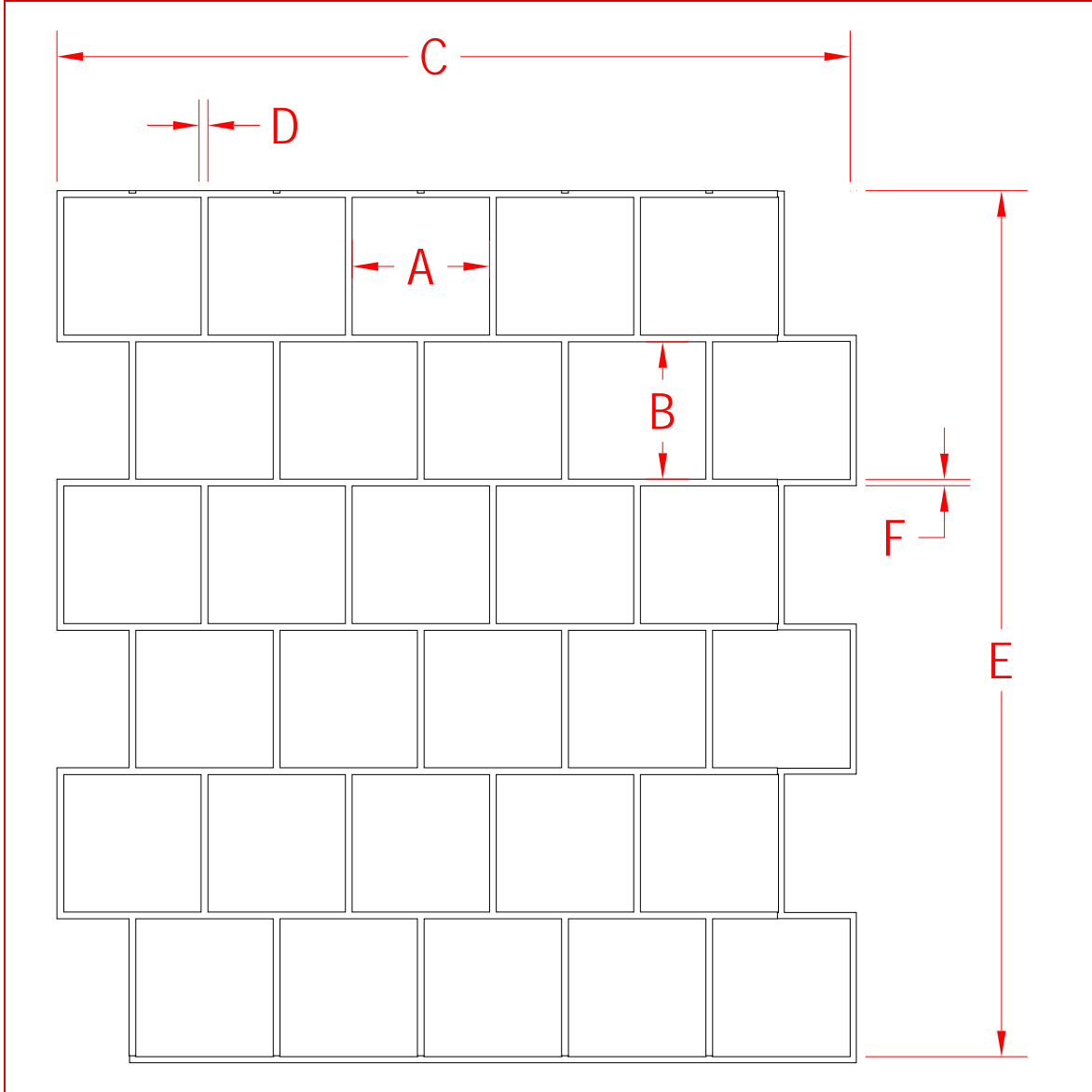

**Coverage / Piece**

Square Feet.... 13.33  
Linear Feet..... 3.54



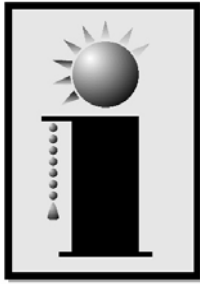

**INNOVATIVE**  
BRICK SYSTEMS, L.L.C.

Innovative Brick Systems, L.L.C.  
11625 Reed Ct.  
Broomfield, Co. 80020  
800-413-4588

**Dimensions**

A... 7 9/16"\*\*\*  
B... 2 1/4"  
C...\* 48"  
D... 7/16"N  
E...\* 21.33 "  
F... .417"

\* ±1/8" for normal thermal expansion and contraction

**VersaLiner®**  
**#101.2**

**Modular Running Bond**  
**Compression Fit Joint\***

Patent Number: D,479,614

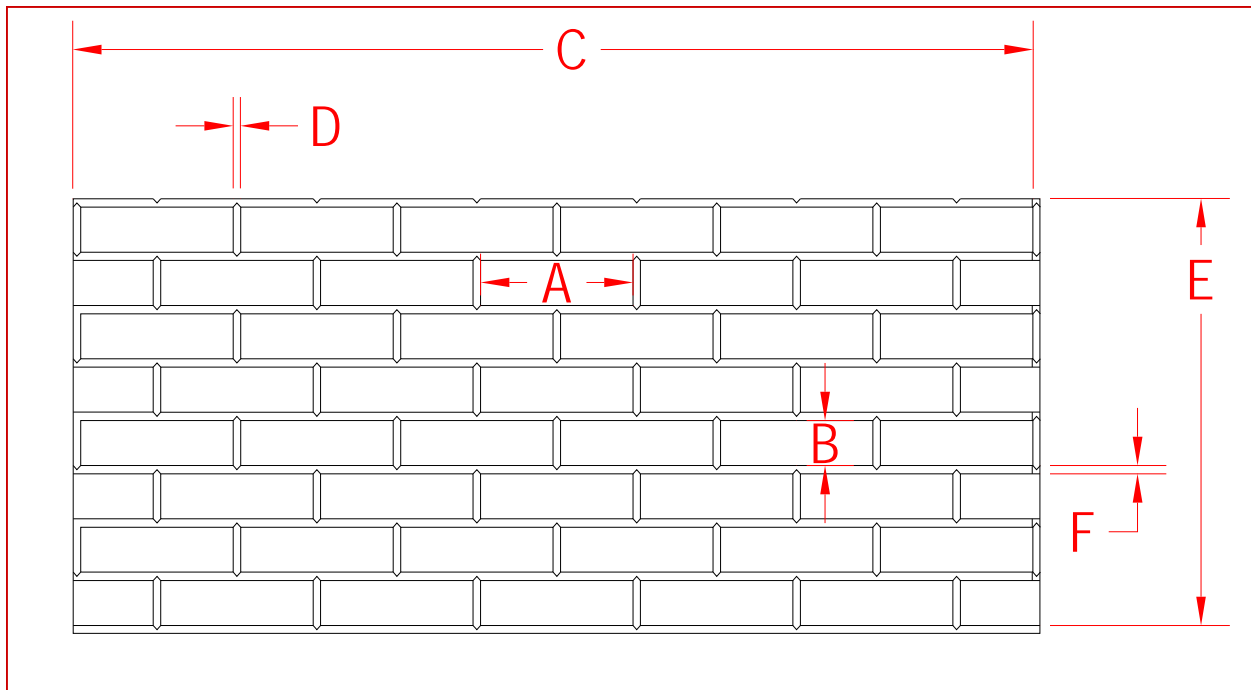

- **\*\*CFJ—“compression fit” vertical joint**
- **Pocket will conform to brick size approx. 7 1/2” - 7 5/8”**

**Coverage / Piece**

Square Feet.... 7.11  
Linear Feet..... 4

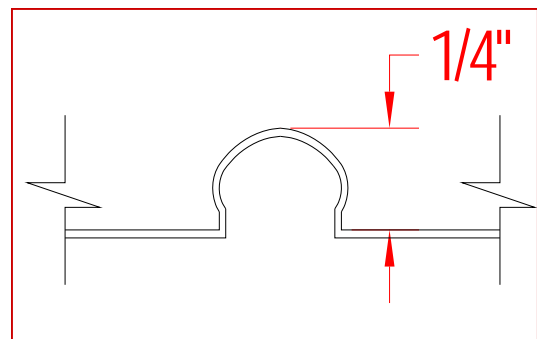

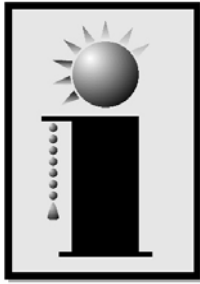

**INNOVATIVE**  
BRICK SYSTEMS, LLC.

**Innovative Brick Systems, L.L.C.**  
11625 Reed Ct.  
Broomfield, Co. 80020  
800-413-4588

**VersaLiner®**  
**#110.011**

**Modular RB Compensating\*  
Compression Fit Textured Joint\***

**Dimensions**

A... 7 5/8" N  
B... 2 1/4"  
C...\* 32 3/16"  
D... 7/16"N  
E...\* 21.33 "  
F... .417"

\* ±1/8" for normal thermal expansion and contraction

**Patent Number: D,479,614**

\* Vertical joints are adjusted to add 3/16" per sheet in horizontal layout.

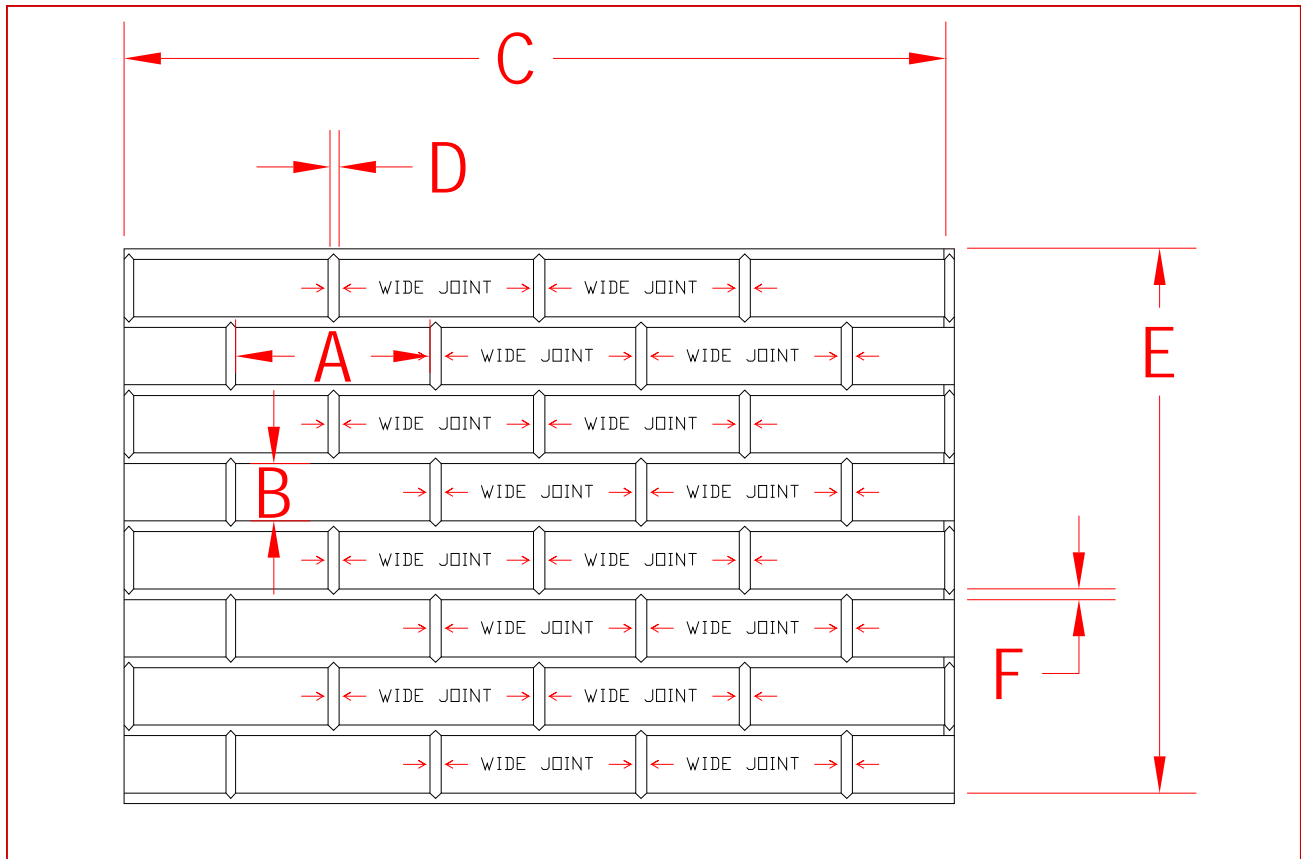

- **\*\*CFTJ—“compression fit” textured joint**
- **Pocket will conform to brick size approx. 7 1/2” - 7 5/8”**

**Coverage / Piece**

Square Feet.... 7.11  
Linear Feet..... 4

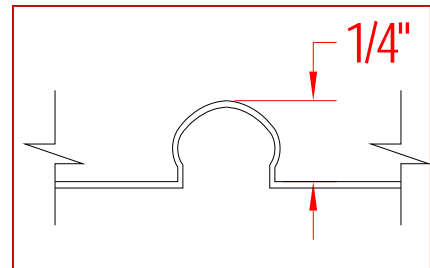

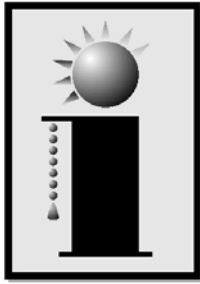

**INNOVATIVE**  
BRICK SYSTEMS, L.L.C.

Innovative Brick Systems, L.L.C.  
11625 Reed Ct.  
Broomfield, Co. 80020  
800-413-4588

**VersaLiner®**  
**#125.012**

**Modular Soldier Compensating\*  
Compression Fit Textured Joint\***

**Dimensions**

A... 2 1/4"  
B... 7 5/8"  
C...\* 32 3/16"  
D... .417"N  
E...\* 8 "  
F... .437"

\* ±1/8" for normal thermal expansion and contraction

**Patent Number: D,479,614**

\* Vertical joints are adjusted to add 3/16" per 32" in horizontal layout.

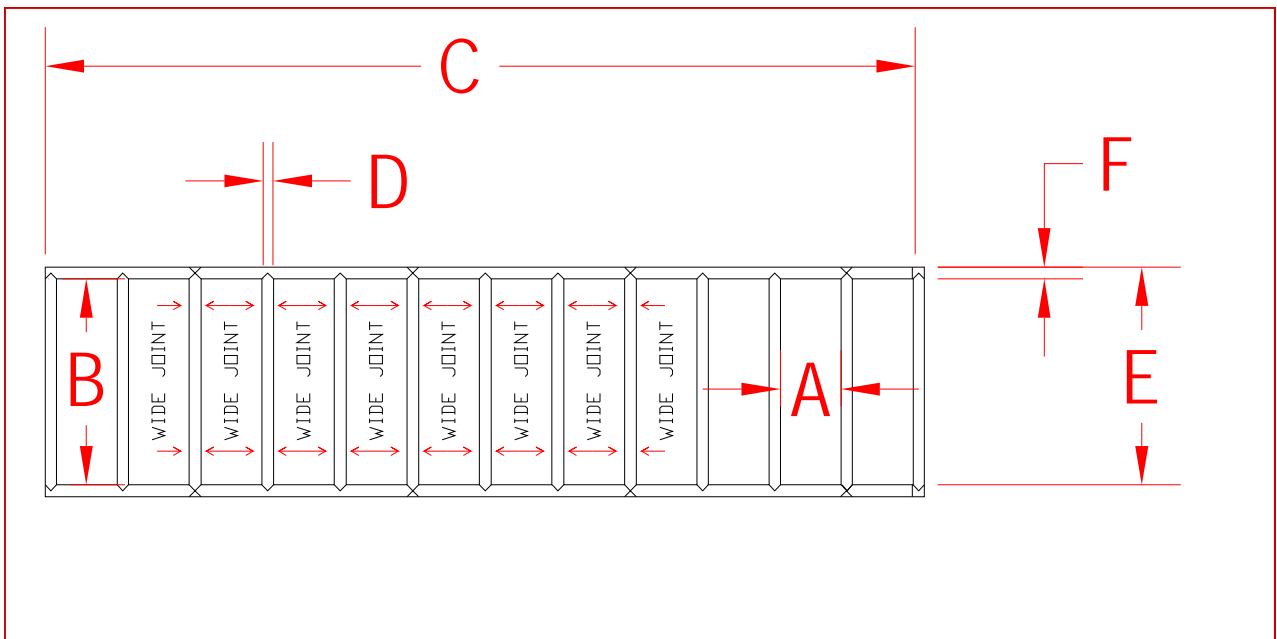

- **\*\*CFTJ—“compression fit” textured joint**
- **Pocket will conform to brick size approx. 7 1/2” - 7 5/8”**

**Coverage / Piece**

Square Feet.... 1.78  
Linear Feet..... 2.67

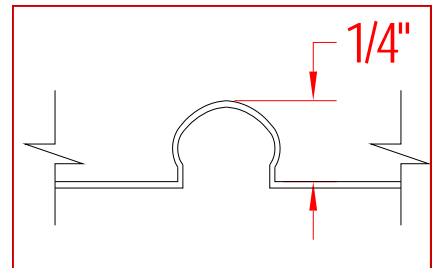

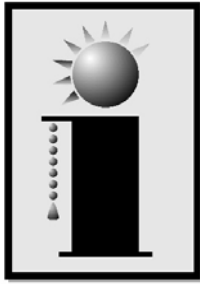

**INNOVATIVE**  
BRICK SYSTEMS, L.L.C.

Innovative Brick Systems, L.L.C.  
11625 Reed Ct.  
Broomfield, Co. 80020  
800-413-4588

**Dimensions**

A... 7 5/8"  
B... 2 1/4"  
C... \* 24"  
D... .1/2"  
E... \* 42.67"  
F... .417"  
G.. .563"

**VersaLiner®**  
**# S-130**

**Modular Running Bond**  
**2' Column Liner**

Patent Number: D,479,614

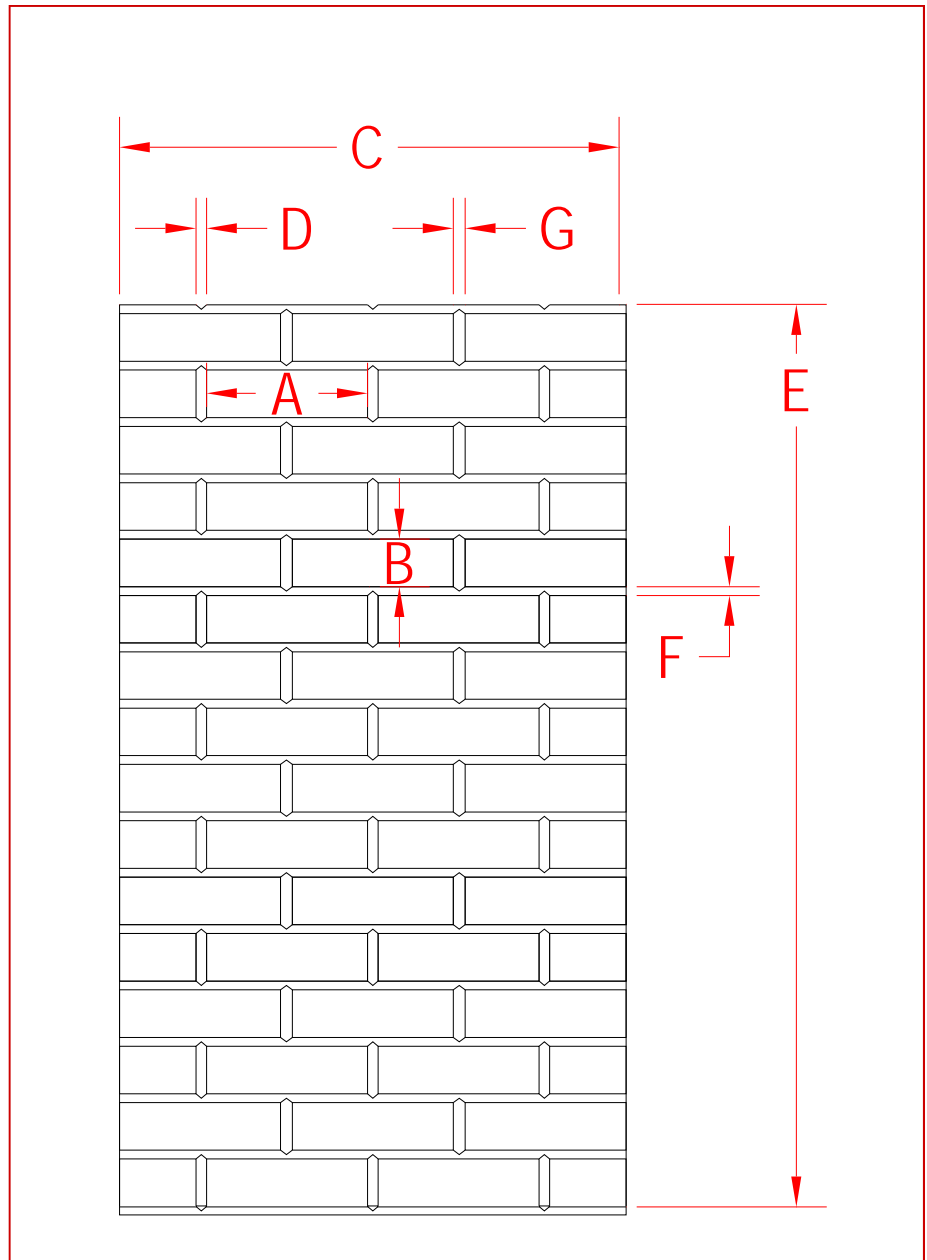

**Coverage / Piece**

Square Feet.... 7.11  
Linear Feet..... 2.00

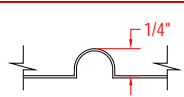

**COVE JOINT**

